

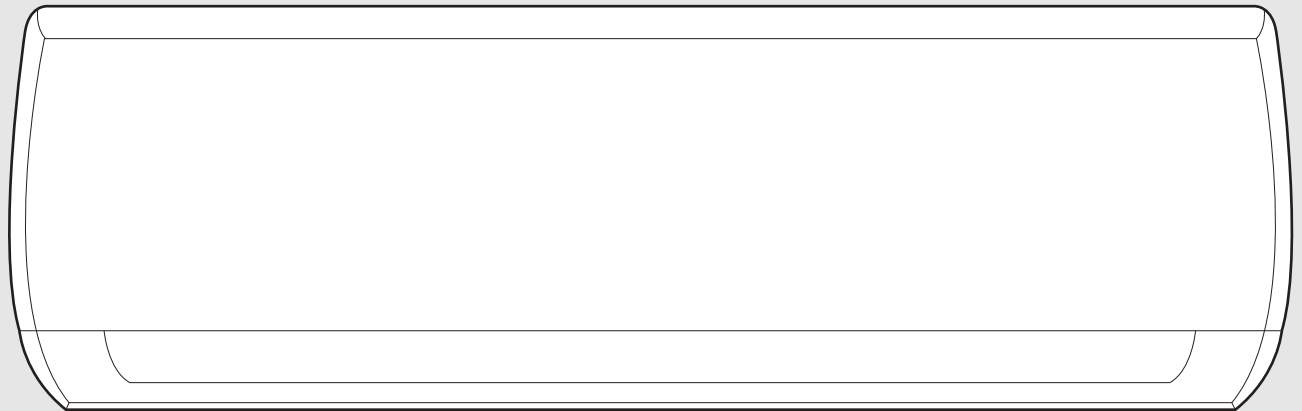

Service instructions

Split air conditioner

**Climate 7000i/7100i**



## Table of contents

<b>1</b>	<b>Explanation of symbols and safety instructions</b>	<b>3</b>	5.6	Quick maintenance by error code	36
1.1	Explanation of symbols	3	5.7	Troubleshooting by error code	37
1.2	General safety instructions	3	5.7.1	EH 00/EH 0A: Indoor unit EEPROM parameter error	37
1.2.1	Overview	3	5.7.2	EC 51: Outdoor EEPROM parameter error or communication error between the outdoor main chip and compressor driven chip EEPROM parameter error	38
1.2.2	Preparation of environments with flammable refrigerants	4	5.7.3	EL 01: Communication error between the indoor and outdoor units	39
<b>2</b>	<b>Specifications</b>	<b>7</b>	5.7.4	EH 02: Zero crossing detection error	41
2.1	Model reference	7	5.7.5	EH 03: Indoor fan speed is operating outside of the normal range	42
2.2	Pipe length and drop height	7	5.7.6	EC 07: The outdoor fan speed is operating outside of the normal range	43
2.3	Refrigerant cycle diagrams	8	5.7.7	EH 60, EH 61: Open or short circuit of indoor temperature sensors	44
2.3.1	Models CL7000iU W 20 E, CL7000iU W 26 E, CL7000iU W 35 E, CL7000iU W 41 E	8	5.7.8	EC 52, EC 53, EC 54, EC 56: Open or short circuit of outdoor temperature sensors	45
2.3.2	Model CL7000iU W 53 E	8	5.7.9	EL 0C: Refrigerant leakage detection	46
2.4	Electrical wiring diagrams	9	5.7.10	EH 0b: Indoor PCB/display board communication error	47
2.4.1	Indoor unit wiring diagram	9	5.7.11	PC 00: IPM malfunction or IGBT over-strong current protection	48
2.4.2	Outdoor unit wiring diagrams	10	5.7.12	PC 01: Over-voltage or undervoltage protection	49
2.4.3	Outdoor unit printed circuit board diagrams	12	5.7.13	PC 02: High temperature protection of compressor/high temperature protection of the IPM module	50
<b>3</b>	<b>Product features</b>	<b>18</b>	5.7.14	PC 03: Low pressure protection	51
3.1	Indoor unit display	18	5.7.15	PC 04: Inverter compressor drive error	52
3.2	Safety features	18	5.7.16	--: Indoor units mode conflict	53
3.3	Operating functions	18	5.7.17	FH 0P: AP mode is active but there is no Wi-Fi kit installed	53
3.3.1	Fan mode	18	5.7.18	EH bE: Communication error between the radar and the display board/radar error	54
3.3.2	Automatic mode	19	<b>6</b>	<b>Check procedures</b>	<b>55</b>
3.3.3	Cooling mode	19	6.1	Before checking	55
3.3.4	Heating mode	20	6.2	Temperature sensor check	55
3.3.5	Dry mode	20	6.3	Compressor check	55
3.3.6	Forced operation function	20	6.4	IPM continuity check	56
3.3.7	Timer function	21	6.5	4-way valve check	56
3.3.8	Sleep mode	21	6.6	EXV check	57
3.3.9	Follow Me function	21	<b>7</b>	<b>Appendix</b>	<b>58</b>
3.3.10	Auto-restart function	21	7.1	Temperature sensor resistance values for T1, T2, T3 and T4	58
3.3.11	Frost protection (8 °C heating)	21	7.2	Temperature sensor resistance values for TP	59
3.3.12	Silent function	21	7.3	Pressure on service port	60
3.3.13	iClean 56°C	21	7.3.1	Cooling chart (R32)	60
3.3.14	Energy saving function	21	7.3.2	Heating chart (R32)	60
3.3.15	Radar detection function	22	7.3.3	System pressure table (R32)	61
3.3.16	Wireless control function	22			
<b>4</b>	<b>Refrigerant</b>	<b>23</b>			
4.1	First time installation check	23			
4.2	Refrigerant recharge	25			
4.3	Re-Installation	26			
4.3.1	Indoor unit	26			
4.3.2	Outdoor unit	28			
<b>5</b>	<b>Diagnosis and troubleshooting</b>	<b>30</b>			
5.1	Safety precautions	30			
5.2	General troubleshooting	31			
5.3	Record Form	31			
5.4	Query	32			
5.5	Error diagnosis and troubleshooting without error code	33			
5.5.1	Remote maintenance	33			
5.5.2	Field maintenance	34			

## 1 Explanation of symbols and safety instructions

### 1.1 Explanation of symbols

#### Warnings

In warnings, signal words at the beginning of a warning are used to indicate the type and seriousness of the ensuing risk if measures for minimising danger are not taken.

The following signal words are defined and can be used in this document:



**DANGER** indicates that severe or life-threatening personal injury will occur.



**WARNING** indicates that severe to life-threatening personal injury may occur.



**CAUTION** indicates that minor to medium personal injury may occur.

#### NOTICE

**NOTICE** indicates that material damage may occur.

#### Important information



The info symbol indicates important information where there is no risk to people or property.

### 1.2 General safety instructions

#### 1.2.1 Overview

This service manual is intended for service engineers. All instructions must be observed. Failure to comply with instructions may result in material damage and personal injury, including danger to life.

- ▶ Read the installation manuals (outdoor unit, indoor unit, etc.) prior to maintenance.
- ▶ Observe the safety instructions and warnings.
- ▶ Follow national and regional regulations, technical regulations and guidelines.

#### Accidents or emergencies

##### **Warning**

- ▶ Immediately turn off the gas and ventilate the area if a gas leak is suspected before turning the unit on.
- ▶ Turn the breaker off and disconnect the power supply cable if strange sounds or smoke are detected in the unit.
- ▶ Contact an authorized service center if the unit comes in contact with liquid.
- ▶ Immediately rinse or wash skin or clothing with clean water if any of these surfaces come in contact with liquid from the batteries.
- ▶ Do not insert hands or other objects into the air inlet or outlet while the unit is plugged in.
- ▶ Do not operate the unit with wet hands.
- ▶ Do not use a remote controller that has previously been exposed to battery damage or leakage.

##### **Caution**

- ▶ Clean and ventilate the unit at regular intervals when installed near a stove or similar devices.
- ▶ Do not use the unit during severe weather conditions. If severe conditions are expected, remove the unit from the window.

#### Pre-installation and installation

##### **Warning**

- The unit should only be used in a dedicated circuit.
- Damage to the installation area could cause the unit to fall. This may result in personal injuries, property damage, or unit failure.
- The disassembly, installation, removal or reparation of the unit should only be performed by qualified personnel.
- The electrical work should only be performed by a qualified electrician. For more information contact the local dealer, seller, or an authorized service center.

##### **Caution**

- While unpacking, be aware of sharp edges around the unit as well as the edges of the fins on the condenser and evaporator.

#### Operation and maintenance

##### **Warning**

- ▶ Do not use defective or under-rated circuit breakers.
- ▶ Make sure the unit is properly grounded and that a dedicated circuit and breaker are installed.
- ▶ Do not modify or extend the power cable. Make sure that the power cable is secured and not damaged during operation.
- ▶ Do not unplug the power supply during operation.
- ▶ Do not store or use flammable materials during operation.
- ▶ Do not open the inlet grill of the unit during operation.
- ▶ Do not touch the electrostatic filter if the unit is equipped with one.
- ▶ Do not block the inlet or outlet of the air flow to the unit.
- ▶ Do not use harsh detergents, solvents, or similar items to clean the unit.
- ▶ Clean the unit using a soft cloth.
- ▶ Do not touch the metal parts of the unit when removing the air filter as they are very sharp.
- ▶ Do not step on or place anything on the unit or outdoor units.
- ▶ Do not drink water drained from the unit.
- ▶ Avoid direct skin contact with water drained from the unit.
- ▶ Use a firm stool or step ladder in accordance with the manufacturer regulations when doing maintenance or cleaning the unit.

##### **Caution**

- ▶ Do not install or operate the unit for an extended period of time in areas of high humidity or in an environment directly exposing the unit to the sea wind or salt spray.
- ▶ Do not install the unit on a defective or damaged installation stand, or in an unsecured location.
- ▶ Make sure that the unit is installed at a levelled position.
- ▶ Do not install the unit where noise or air discharge created by the outdoor unit will negatively impact the environment or nearby residences.
- ▶ Do not directly expose skin to the air discharged by the unit for extended periods of time.
- ▶ Make sure that the unit does not operate in areas with water or other liquids.
- ▶ Make sure that the drain hose is correctly installed to ensure proper water drainage.
- ▶ Use two or more people to lift or transport the unit.

- ▶ Disconnect the power supply or turn off the breaker if the unit will not be used for an extended period of time.

### 1.2.2 Preparation of environments with flammable refrigerants

#### Checks to the area

Prior to beginning work on systems containing flammable refrigerants, safety checks are necessary to ensure that the risk of ignition is minimized.

#### Work procedure

Work shall be undertaken under a controlled procedure so as to minimise the risk of a flammable gas or vapour being present while the work is being performed.

The technical personnel in charge of operation, supervision and maintenance of air-conditioning systems shall be adequately instructed and specialized.

Work shall be undertaken with appropriate tools only (in case of doubt, ask the manufacturer of the tools to check which ones to use with flammable refrigerants).

#### General work area

All maintenance staff and others working in the local area shall be instructed on the nature of work being carried out. Work in confined spaces shall be avoided.

The area around the work space shall be sectioned off.

- ▶ Make sure that the conditions within the area have been made safe by controlling flammable material.

#### Checking for presence of refrigerant

The area shall be checked with an appropriate refrigerant detector prior to and during work, to ensure the technician is aware of potentially toxic or flammable atmospheres.

- ▶ Ensure that the leak detection equipment being used is suitable for use with all applicable refrigerants, i.e. non-sparking, adequately sealed or intrinsically safe.

#### Presence of fire extinguisher

If any hot work is to be conducted on the refrigerating equipment or any associated parts, appropriate fire extinguishing equipment shall be available to hand.

- ▶ Have a dry powder or CO<sub>2</sub> fire extinguisher adjacent to the charging area.

#### No ignition sources

- No person carrying out work in relation to a refrigerating system which involves exposing any pipe work shall use any sources of ignition in such a manner that it may lead to the risk of fire or explosion.
- All possible ignition sources, including cigarette smoking, should be kept sufficiently far away from the site of installation, repairing, removing and disposal, during which refrigerant can possibly be released to the surrounding space.
- Prior to work taking place, the area around the equipment is to be surveyed to make sure that there are no flammable hazards or ignition risks. "No Smoking" signs shall be displayed.

#### Ventilated area

- ▶ Make sure that the area is adequately ventilated before breaking into the system or conducting any hot work.
- A degree of ventilation shall continue during the period that the work is carried out.
- The ventilation should safely disperse any released refrigerant and preferably expel it externally into the atmosphere.

#### Checks to the refrigeration equipment

- Changes to electrical components should be fit for the purpose and for the correct specification. The service and maintenance guidelines of the manufacturer should be followed at all times.
- The following checks shall be applied to installations using flammable refrigerants:
  - the charge size depends on the room size, within which the parts containing the refrigerant will be installed;
  - the ventilation machinery and outlets are operating adequately and are not obstructed;
  - if an indirect refrigerant circuit is being used, the secondary circuit shall be checked for the presence of refrigerant. The marking made to the unit shall continue to be visible and legible;
  - illegible markings and signs shall be corrected;
  - refrigerant piping or components shall be installed in a position safe from substances which may corrode components containing refrigerant, unless the components are made of materials inherently resistant to or suitably protected against corrosion.

#### Checks to electrical devices

- Repair and maintenance to electrical components shall include initial safety checks and component inspection procedures.
- If a fault exists that could compromise safety, then no electrical supply shall be connected to the circuit until it is satisfactorily dealt with. If the fault cannot be corrected immediately but it is necessary to continue operation, an adequate temporary solution shall be used. This shall be reported to the owner of the equipment so all parties are advised.
- Initial safety checks shall include:
  - that capacitors are discharged: this shall be done in a safe manner to avoid possibility of sparking;
  - that no live electrical components and wiring are exposed while charging, recovering or purging the system;
  - that there is continuity of earth bonding.

#### Repairs to sealed components

During repairs to sealed components, all electrical supplies shall be disconnected from the equipment being worked upon prior to any removal of sealed covers, etc.

If it is absolutely necessary to have an electrical supply to equipment during servicing, then a permanently operating form of leak detection shall be located at the most critical point to warn of a potentially hazardous situation.



Particular attention shall be paid to the following to ensure that by working on electrical components the casing is not altered in such a way that the level of protection is affected.

This shall include damage to cables, excessive number of connections, terminals not made to original specification, damage to seals, incorrect fitting of glands, etc.

- ▶ Make sure that the unit is securely mounted.
- ▶ Make sure that seals or sealing materials have not degraded to the point that they no longer serve the purpose of preventing the ingress of flammable atmospheres.



The use of silicon sealant may inhibit the effectiveness of some types of leak detection equipment.

Intrinsically safe components do not have to be isolated prior to working on them.

### Repair to intrinsically safe components

- ▶ Do not apply any permanent inductive or capacitance loads to the circuit without ensuring that this will not exceed the permissible voltage and current permitted for the equipment in use.
- ▶ The test apparatus shall be at the correct rating. Intrinsically safe components are the only types that can be worked on while live in the presence of a flammable atmosphere.

#### NOTICE

### Risk of refrigerant ignition and leakage

Using parts not specified by manufacturer may result in the ignition of refrigerant in the atmosphere from a leak.

- ▶ Replace components only with parts specified by the manufacturer.

### Cabling

- ▶ Make sure that the cabling will not be subject to wear, corrosion, excessive pressure, vibration, sharp edges or other adverse environmental effects.
- ▶ Check that the effects of aging or continual vibration from sources such as compressors or fans.

### Detection of flammable refrigerants

Under no circumstances shall potential sources of ignition be used in searching for refrigerant leaks.

- ▶ Do not use a halide torch (or any other detectors that use a naked flame).

### Leak detection methods



Leak detection fluids are suitable for use with most refrigerants. However, the use of detergents containing chlorine should be avoided, as the chlorine may react with the refrigerant and corrode the copper pipe-work. The use of silicone sealant may inhibit the effectiveness of some types of leak detection equipment.

The following leak detection methods are deemed acceptable for systems containing flammable refrigerants:

- ▶ Make sure that the detector is not a potential source of ignition and is suitable for the refrigerant. For this reason, use electronic leak detectors to detect flammable refrigerants.
- ▶ Make sure to recalibrate an inadequate sensitivity in a refrigerant-free area.
- ▶ Make sure to follow the appropriate percentage of gas (25% maximum).
- Leak detection equipment should be set at a percentage of the LFL of the refrigerant and be calibrated to the refrigerant employed.
- If a leak is suspected, all open flames shall be extinguished.
- If a refrigerant leakage is found which requires brazing, all of the refrigerant must be either recovered from the system or isolated by shutting-off valves in a part of the system away from the leak.

### Removal and evacuation



When breaking into the refrigerant circuit to make repairs - or for any other purpose - conventional procedures may be used. Do not use compressed air or oxygen to purge refrigerant systems.

- ▶ Do not open the refrigerant system by brazing. Instead, adhere to the following procedure:
- ▶ Remove the refrigerant.
- ▶ Flush the circuit with nitrogen.
- ▶ Evacuate.
- ▶ Flush again with nitrogen. This process may need to be repeated several times.
- ▶ Open the circuit by cutting or brazing.

### Removal and evacuation for appliances containing flammable refrigerant

#### NOTICE

### Flushing pipes containing flammable refrigerants

For appliances containing flammable refrigerants, the system should be flushed with oxygen-free nitrogen to render the unit safe.

- ▶ Always follow best practice.
- ▶ Flushing is achieved by vacuuming the system, then filling the system with oxygen-free nitrogen until the design pressure is reached.
- ▶ Vent the system to atmospheric pressure.
- ▶ Repeat the above process until there is no refrigerant left in the system.
- ▶ Make sure to always flush the system before doing any brazing on the pipework.



Make sure that the outlet for the vacuum pump is away from any sources of ignition and that ventilation is available.

### Charging procedures

Follow these requirements in addition to conventional charging procedures:

- ▶ make sure that no contamination of different refrigerant occurs when using charging equipment.
- ▶ Keep hoses or lines as short as possible to minimise the amount of refrigerant contained in them.
- ▶ Keep refrigerant cylinders upright.
- ▶ Label the system when charging is complete (if not already labelled).
- ▶ Before recharging the system, pressure-test with oxygen-free nitrogen.
- ▶ Take extreme care not to overfill the refrigeration system.
- ▶ Leak-test the system on completing charging and prior to commissioning. A follow-up leak test should be carried out before leaving the site.

## Decommissioning



Before carrying out this procedure, it is essential that the technician is completely familiar with the equipment and all the related details.

The recommended good practice is that all refrigerants are recovered safely or safely vented.

- ▶ An oil and refrigerant sample should be taken prior to the task, in case analysis is required before reusing reclaimed refrigerant.
- ▶ Make sure that:
  - electrical power is available before starting the work;
  - the system is electrically isolated;
  - mechanical equipment for handling refrigerant recovery into cylinders is available (if required);
  - recovery equipment and cylinders conform to the appropriate standards;
  - all personal protective equipment is available and being used correctly;
  - the recovery process is supervised at all times by a competent person;
  - the recovery equipment and cylinders are in accordance with the appropriate standards.
- ▶ Pump down the refrigerant system, if possible.
- ▶ Make a manifold so that the refrigerant can be removed from various parts of the system when vacuuming is not possible.
- ▶ Make sure that the cylinder is situated on the scales before recovery takes place.
- ▶ Start the recovery machine and operate in accordance with the instructions from the manufacturer.
- ▶ Do not overfill cylinders (no more than 80% of the water capacity, converted to refrigerant density at the temperature of recovery).
- ▶ Never exceed the maximum working pressure of the cylinder, not even temporarily.
- ▶ Make sure that the cylinders and the equipment are removed from the site promptly and that all isolation valves on the equipment are closed off when the process is finished.



Recovered refrigerants should only be charged into another refrigeration system after they have been cleaned and checked first.

## Labelling

- ▶ Make sure that the equipment label states that it has been decommissioned and emptied of refrigerant and that the label is dated and signed.
- ▶ Make sure that the equipment is labelled to state it contains flammable refrigerant.

## Recovery



When removing refrigerant from a system, either for service or decommissioning, it is recommended good practice that all refrigerants are removed safely.

- ▶ Make sure that only appropriate refrigerant recovery cylinders are used and that they are appropriately labelled for the refrigerant. Cylinders must come completely with pressure relief valve and all associated shut-off valves in good working order.
- ▶ Make sure that a sufficient amount of cylinders to hold the total system charge is available.

- ▶ Make sure that empty recovery cylinders are evacuated and, if possible, cooled before recovery takes place.
- ▶ Make sure that the recovery equipment is in good working order and suitable for the recovery of flammable refrigerants.
- ▶ Make sure that the instructions concerning the equipment at hand are included.
- ▶ Make sure that a set of calibrated weighing scales in good working order is available.
- ▶ Make sure that hoses are complete with leak-free disconnect couplings and are in good condition.
- ▶ Before use, check that recovery machine is in satisfactory working order, has been properly maintained, and that any associated electrical components are sealed to prevent ignition in the event of a refrigerant release. Consult the manufacturer if in doubt.
- ▶ Make sure that the recovered refrigerant is returned to the refrigerant supplier in the correct recovery cylinder, with the relevant waste transfer note attached.
- ▶ Do not mix refrigerants in recovery units and especially not in cylinders.



If compressors or compressor oils are to be removed, make sure that they have been evacuated to an acceptable level so that no flammable refrigerant remains in the lubricant. The evacuation should only be carried out prior to returning the compressor to the suppliers. Only electric heating to the compressor body may be used to accelerate this process.

When oil is drained from a system, it shall be carried out safely.

## 2 Specifications

### 2.1 Model reference

Refer to the following table to determine the specific indoor and outdoor unit model.

Indoor unit	Outdoor unit	Capacity		Power Supply
		(Btu/h)	(kW)	
CL7000iU W 20 E	CL7000i 20 E	7k	2.0	220-240V~, 50Hz, 1Phase
CL7000iU W 26 E	CL7000i 26 E	9k	2.6	
CL7000iU W 35 E	CL7000i 35 E	12k	3.5	
CL7000iU W 41 E	CL7000i 41 E	14k	4.1	
CL7000iU W 53 E	CL7000i 53 E	18k	5.3	

Table 1

### 2.2 Pipe length and drop height

The length and elevation of the connection piping are shown in table 2. If the pipe length exceeds the maximum pipe length, additional refrigerant must be charged to make sure that there is a nominal cooling/heating capacity.

Capacity		Standard length [m]	Max. pipe length [m]	Max. elevation [m]	Additional refrigerant
Btu/h	kW				
< 15k	< 4.1	5	25	10	12g/m
18	5.3		30	20	

Table 2

**NOTICE**

**Liquid compression or deterioration of oil return**

If the outdoor unit is installed higher than the indoor unit, proper oil return to the compressor along with the suction of refrigerant to keep the lubrication of the compressor.

- ▶ Install an oil trap every 6m of vertical gas pipe to prevent compressor damage.

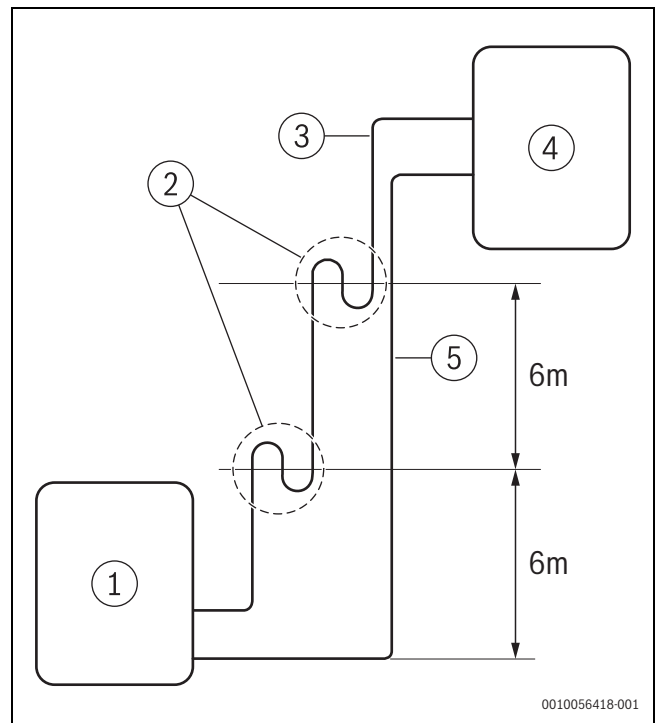

Fig. 1

- [1] Indoor/outdoor unit
- [2] Oil trap
- [3] Gas pipe
- [4] Indoor/outdoor unit
- [5] Liquid pipe

### 2.3 Refrigerant cycle diagrams

#### 2.3.1 Models CL7000iU W 20 E, CL7000iU W 26 E, CL7000iU W 35 E, CL7000iU W 41 E

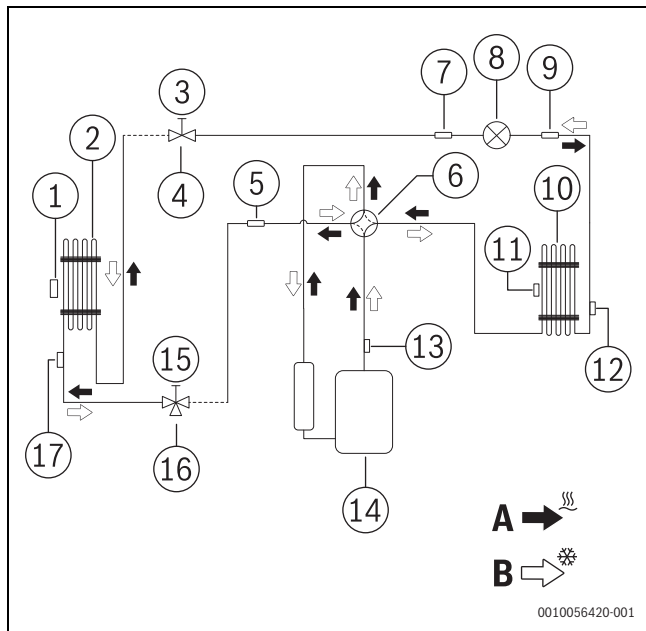

Fig. 2

- [1] T1 sensor (indoor)
  - [2] Indoor heat exchanger
  - [3] Liquid side
  - [4] 2-way valve
  - [5] Muffler
  - [6] 4-way valve
  - [7] Strainer
  - [8] Electronic expansion valve (EEV)
  - [9] Strainer
  - [10] Outdoor heat exchanger
  - [11] Outdoor temperature sensor (T4)
  - [12] Condenser temperature sensor (T3)
  - [13] Discharge temperature sensor (TP)
  - [14] Compressor
  - [15] Gas side
  - [16] 3-way valve
  - [17] Evaporator temperature sensor (T2)
- A Heating  
B Cooling

#### 2.3.2 Model CL7000iU W 53 E

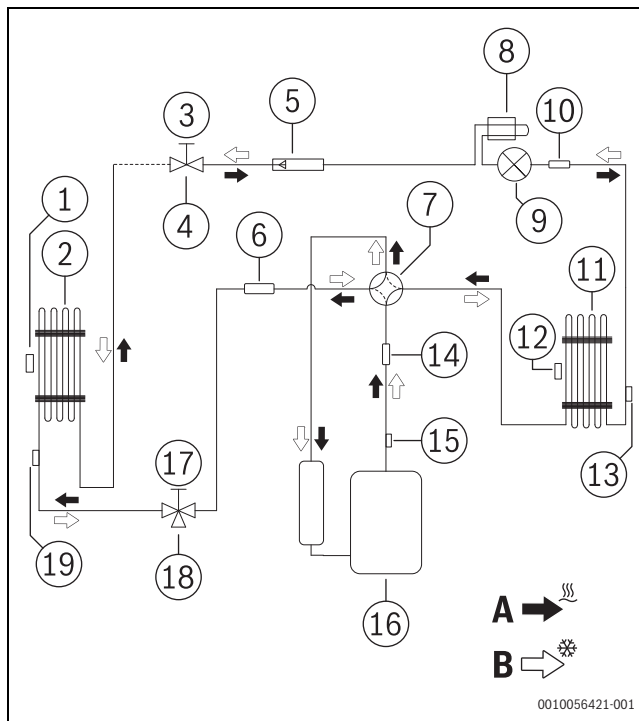

Fig. 3

- [1] T1 sensor (indoor)
  - [2] Indoor heat exchanger
  - [3] Liquid side
  - [4] 2-way valve
  - [5] Throttle hole
  - [6] Muffler
  - [7] 4-way valve
  - [8] Cold plate
  - [9] Electronic expansion valve (EEV)
  - [10] Strainer
  - [11] Outdoor heat exchanger
  - [12] Outdoor temperature sensor (T4)
  - [13] Condenser temperature sensor (T3)
  - [14] Muffler
  - [15] Discharge temperature sensor (TP)
  - [16] Compressor
  - [17] Gas side
  - [18] 3-way valve
  - [19] Evaporator temperature sensor (T2)
- A Heating  
B Cooling

**2.4 Electrical wiring diagrams**

**2.4.1 Indoor unit wiring diagram**

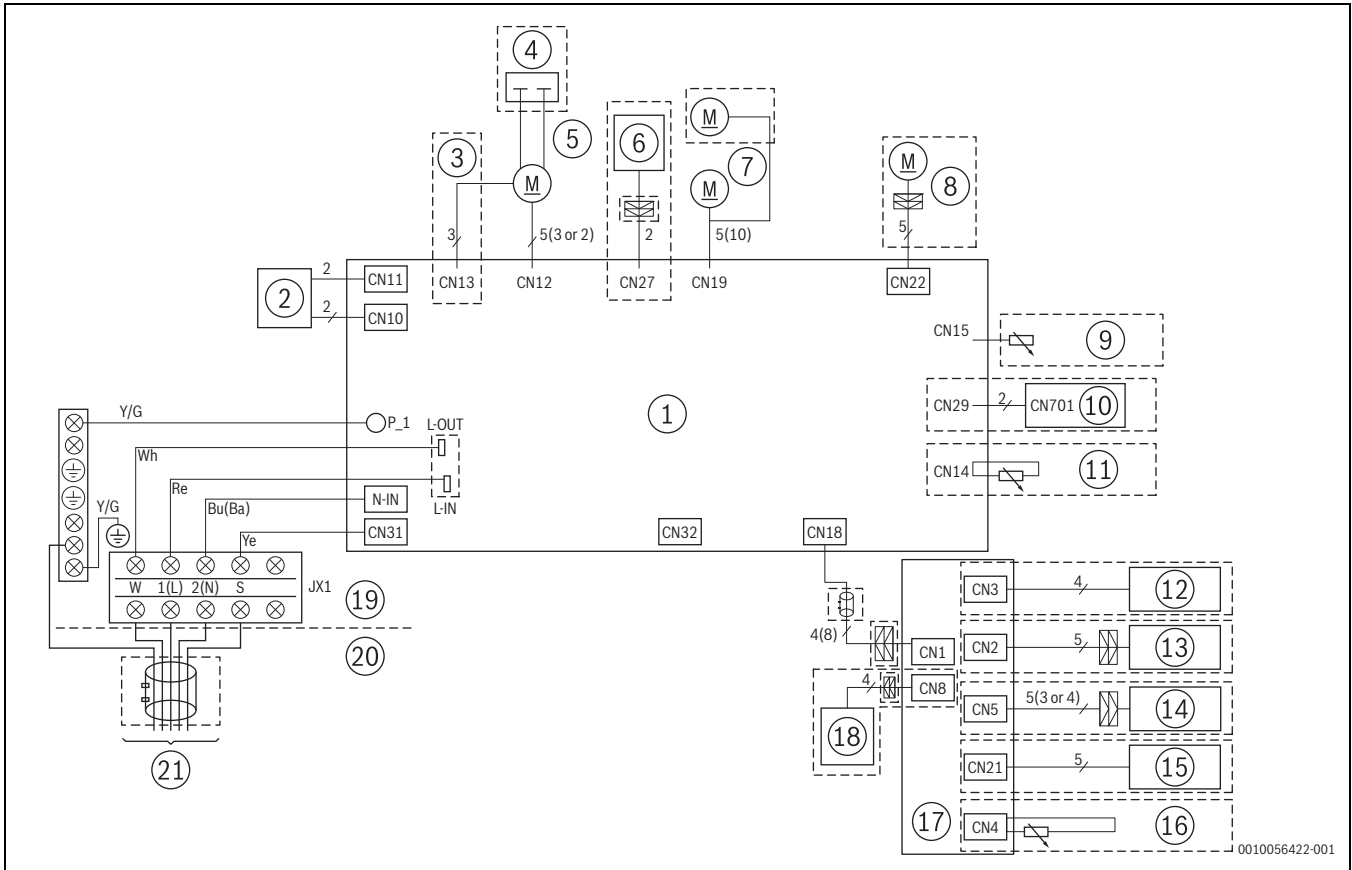
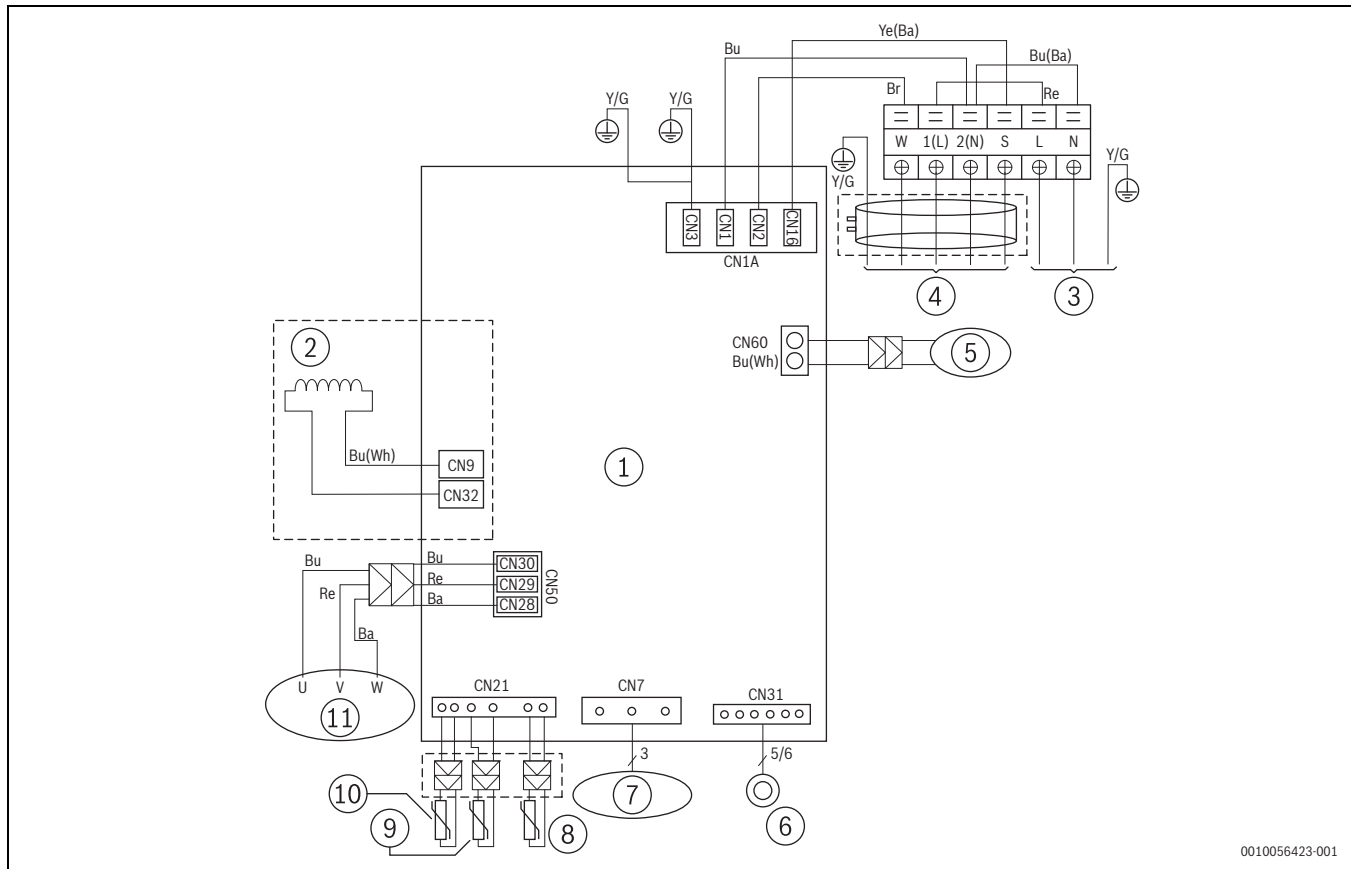

Fig. 4 Wiring diagram for the indoor units from 7 to 18k Btu/h

- |                              |                             |
|------------------------------|-----------------------------|
| [1] Main board               | JX1 Connector indoor unit   |
| [2] Transformer/power board  | Bu (Ba) Blue or black wire  |
| [3] Fanback                  | Re Red wire                 |
| [4] Capacitor                | Ye Yellow wire              |
| [5] Indoor fan               | Ye/Gn Yellow and green wire |
| [6] Negative ion generator   | Wh White wire               |
| [7] Swing motor              | CN.. Port code              |
| [8] Vertical swing motor     | P Electronic dust collector |
| [9] Pipe temperature sensor  | --- Optional element        |
| [10] Switch board            |                             |
| [11] Room temperature sensor |                             |
| [12] Wi-Fi controller        |                             |
| [13] Wire controller         |                             |
| [14] Infrared sensor         |                             |
| [15] Humidity sensor         |                             |
| [16] Room temperature sensor |                             |
| [17] Display board           |                             |
| [18] Radar                   |                             |
| [19] Indoor unit             |                             |
| [20] Outdoor unit            |                             |
| [21] To outdoor unit         |                             |

2.4.2 Outdoor unit wiring diagrams



0010056423-001

Fig. 5 Wiring diagram for outdoor unit with 7 to 14k BTU/h

- |  |                              |
|--|------------------------------|
| [1] Main board                         | Br Brown wire                |
| [2] Reactor                            | Bu Blue wire                 |
| [3] Power supply                       | Re Red wire                  |
| [4] Indoor unit                        | Ye Yellow wire               |
| [5] 4-way valve                        | Ba Black wire                |
| [6] Electronic expansion valve         | Bu (Ba) Blue or black wire   |
| [7] Outdoor unit DC fan                | Bu (Wh) Blue or white wire   |
| [8] Outdoor temperature sensor (T4)    | Ye (Ba) Yellow or black wire |
| [9] Condenser temperature sensor (T3)  | Ye/Gn Yellow and green wire  |
| [10] Discharge temperature sensor (TP) | Wh White wire                |
| [11] Compressor                        | CN.. Port code               |
|  | --- Optional element         |



For standby control the cross section area of the communication cable connected to W, 1(L) and 2(N) must be selected to suit the maximum system current. The maximum system current is equal to the sum of indoor unit and outdoor unit rated current.

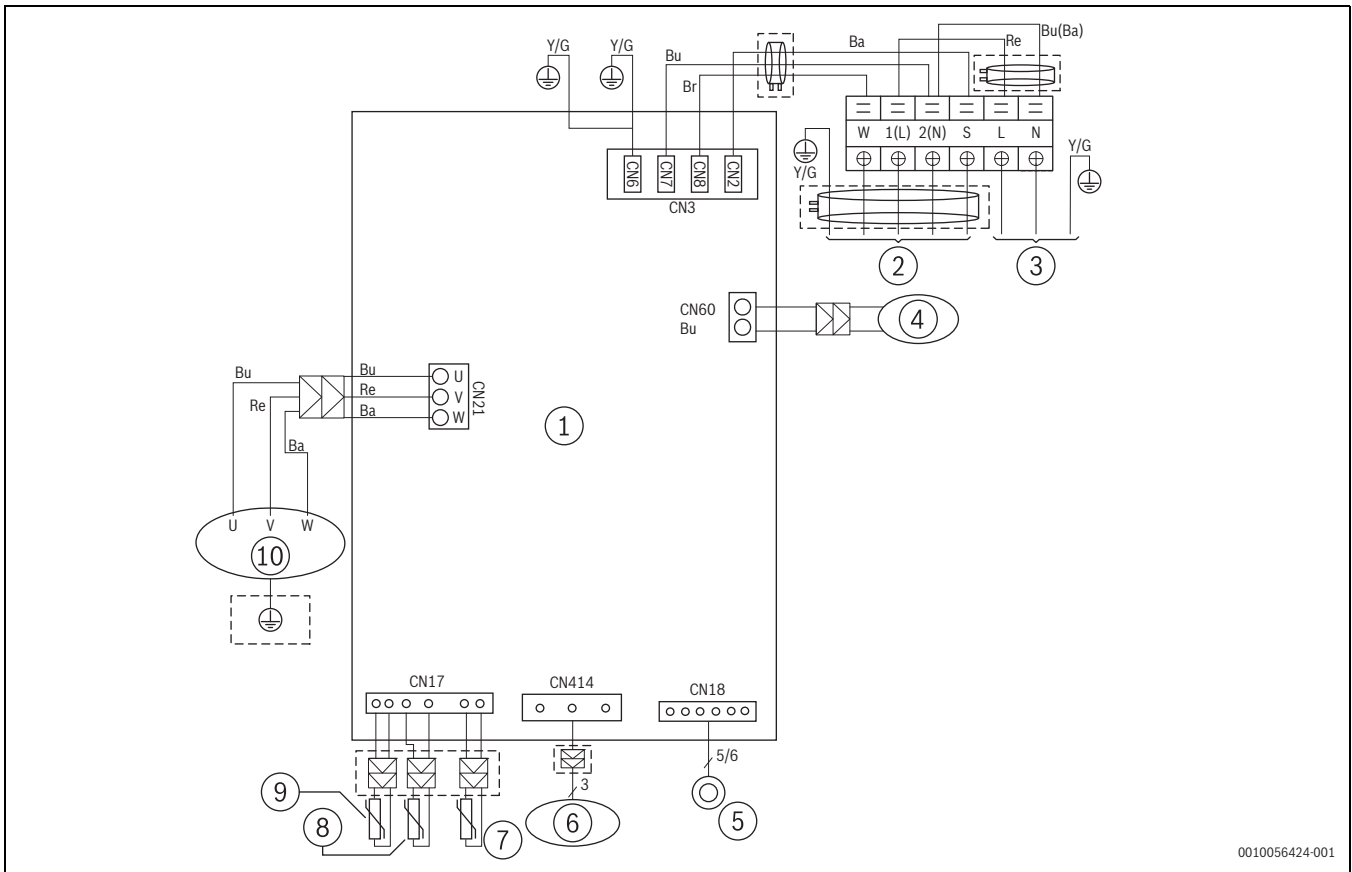

0010056424-001

Fig. 6 Wiring diagram for outdoor unit with 18k BTU/h

- [1] Outdoor main PCB
- [2] Power supply
- [3] Indoor unit
- [4] 4-way valve
- [5] Electronic expansion valve
- [6] Outdoor unit DC fan
- [7] Outdoor temperature sensor (T4)
- [8] Condenser temperature sensor (T3)
- [9] Discharge temperature sensor (TP)
- [10] Compressor (the D box contains the ground wire of the compressor)

- Br Brown wire
- Bu Blue wire
- Ba Black wire
- Wh White wire
- Re Red wire
- Ye Yellow wire
- Bu (Ba) Blue or black wire
- Ye/Gn Yellow and green wire
- CN.. Port code
- Optional element



For standby control the cross section area of the communication cable connected to W, 1(L) and 2(N) must be selected to suit the maximum system current. The maximum system current is equal to the sum of indoor unit and outdoor unit rated current.

**2.4.3 Outdoor unit printed circuit board diagrams**

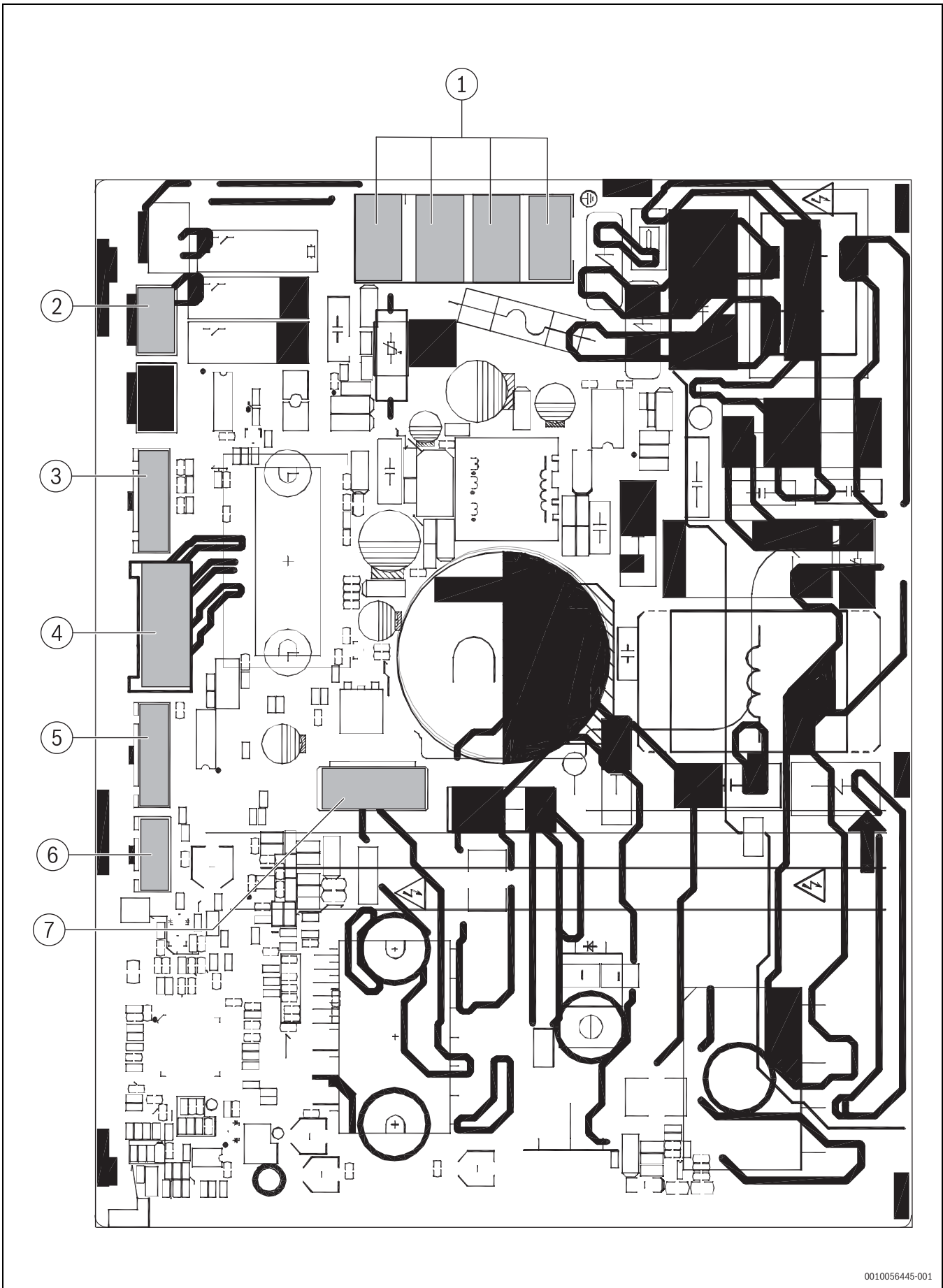

Fig. 7

Label in Fig. 7	Port	Name	Content	Port voltage
<b>1</b>	CN3	CN1A	Earth: connect to Ground	
	CN1		N_in: connect to N-line	208-230V AC
	CN2		L_in: connect to L-line	208-230V AC
	CN16		S: connect to indoor unit communication	
<b>2</b>	CN60	4-way	connect to 4 way valve	208-230V AC (when ON)
<b>3</b>	CN21	TP, T4, T3	connect to pipe temperature sensor T3, ambient temperature sensor T4, discharge temperature sensor TP	
<b>4</b>	CN7	DC-FAN	connect to DC fan	
<b>5</b>	CN31	PMV	connect to the electric expansion valve	
<b>6</b>	CN6	TESTPORT	used for testing	
<b>7</b>	CN50	W	Compressor connection	<ul style="list-style-type: none"> <li>• Standby: 0V AC</li> <li>• Running: 10-200V AC</li> </ul>
		V		
		U		

Table 3



Actual appliance might differ. This section is for reference only.

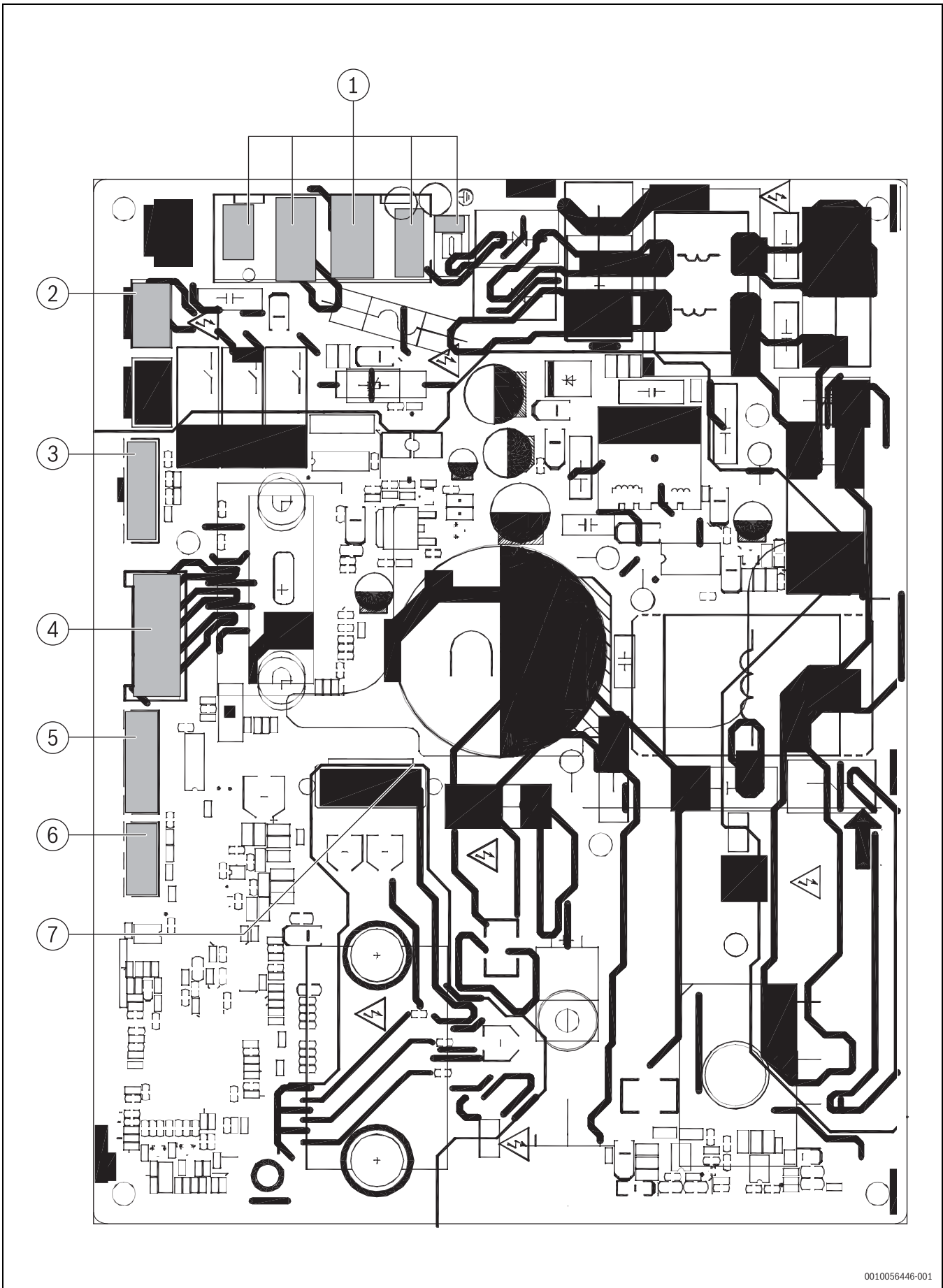

Fig. 8 Main PCB ports for the outdoor units with 9 to 14k BTU/h

Label in Fig. 8	Port	Name	Content	Port voltage
<b>1</b>	CN3	CN1A	Earth: connect to Ground	
	CN1		N_in: connect to N-line	208-230V AC
	CN2		L_in: connect to L-line	208-230V AC
	CN16		S: connect to indoor unit communication	
<b>2</b>	CN60	4-WAY	Connect to 4 way valve	208-230V AC (when ON)
<b>3</b>	CN21	TP, T4, T3	Connect to pipe temperature sensor T3, ambient temperature sensor T4, discharge temperature sensor TP	
<b>4</b>	CN7	DC-FAN	connect to DC fan	
<b>5</b>	CN31	PMV	Connect to the electric expansion valve	
<b>6</b>	CN6	TESTPORT	Used for testing	
<b>7</b>	CN50	U	Compressor connection	<ul style="list-style-type: none"> <li>• Standby: 0V AC</li> <li>• Running: 10-200V AC</li> </ul>
		V		
		W		

Table 4



Actual appliance might differ. This section is for reference only.

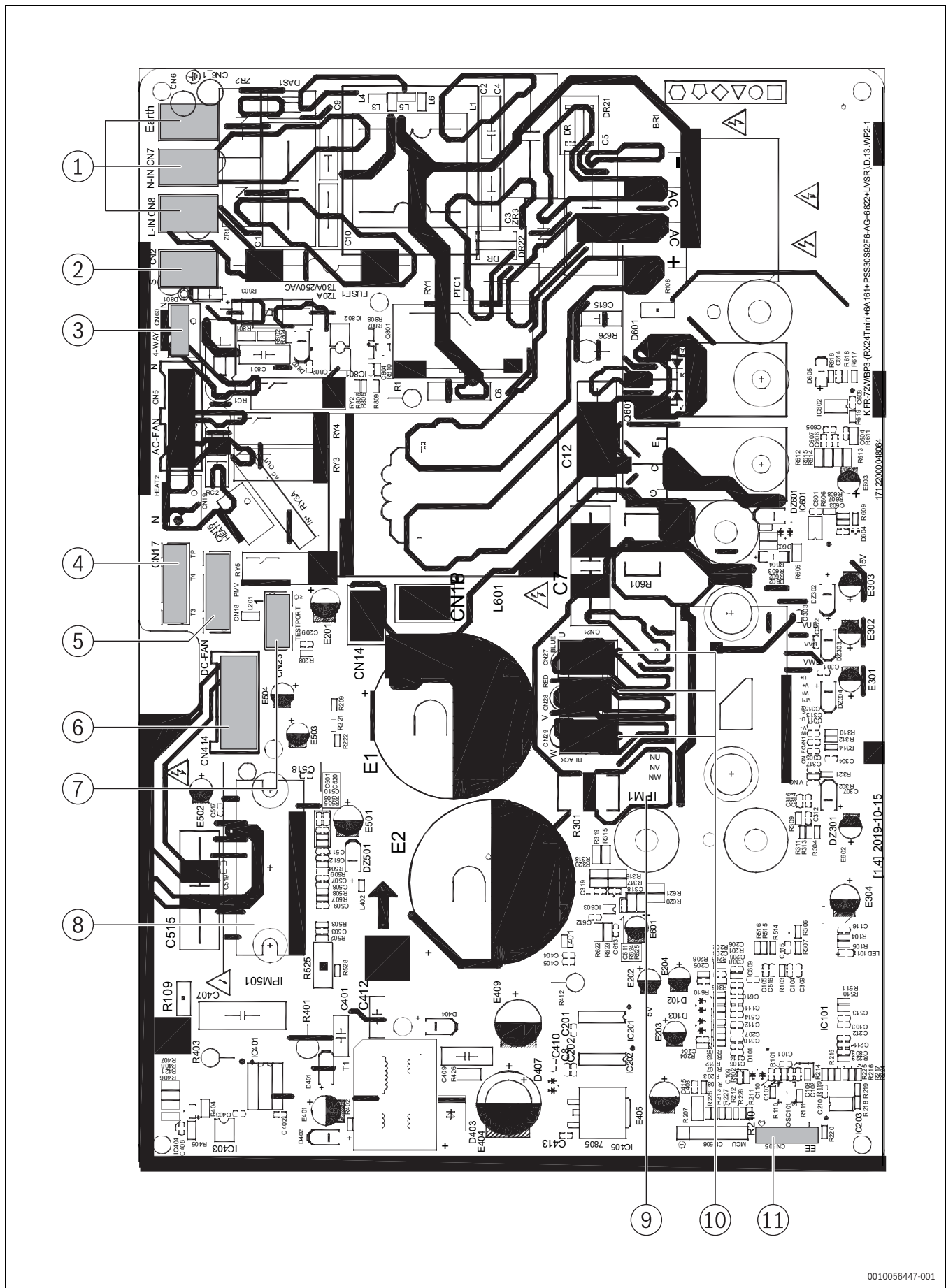

Fig. 9 Main PCB ports for the outdoor unit with 18k BTU/h

Label in Fig. 9	Port	Name	Content	Port voltage
<b>1</b>	CN6	Power supply	Earth: connect to Ground	
	CN7		N_in: connect to N-line	208-230V AC
	CN8		L_in: connect to L-line	208-230V AC
<b>2</b>	CN2	S	S: connect to indoor unit communication	
<b>3</b>	CN60	4-WAY	Connect to 4 way valve	208-230V AC (when ON)
<b>4</b>	CN17	TP, T4, T3	Connect to pipe temperature sensor T3, ambient temperature sensor T4, discharge temperature sensor TP	
<b>5</b>	CN18	PMV	Connect to the electric expansion valve	
<b>6</b>	CN414	DC-FAN	Connect to DC fan	
<b>7</b>	CN23	TESTPORT	used for testing	
<b>8</b>	IPM501	FAN_IPM	IPM for DC fan	
<b>9</b>	IPM1	COMP_IPM	IPM for compressor	
<b>10</b>	CN27	U	Compressor connection	<ul style="list-style-type: none"> <li>• Standby: 0V AC</li> <li>• Running: 200-300V AC</li> </ul>
	CN28	V		
	CN29	W		
<b>11</b>	CN505	EE_PORT	EEPROM programmer port	

Table 5



Actual appliance might differ. This section is for reference only.

### 3 Product features

#### 3.1 Indoor unit display





Symbol	Explanation
<b>Number</b>	Temperature display
	WLAN connection active
	Indicates that the ON timer is active when the indoor unit is switched off. Displayed when FRESH, SWING, TURBO, ECO+, BREEZE or SILENCE features are switched on.
<b>OF (3s)</b>	Timer is set to OFF. FRESH, SWING, TURBO, ECO+, BREEZE or SILENCE features are switched off.
<b>dF</b>	Defrosting feature active
<b>FP</b>	8 °C and 12 °C heating feature is turned on.
<b>CL</b>	Displayed when the active clean feature is switched on.

Table 6 Symbols in the display

#### 3.2 Safety features

##### Compressor three-minute delay at restart

Compressor functions are delayed for up to 10 seconds upon first starting the unit and for up to 3 minutes upon subsequent restarts.

##### Automatic shut-off based on discharge temperature

If the compressor discharge temperature exceeds a certain level for a period of time, the compressor ceases operation.

##### Automatic shut-off based on fan speed

If the indoor fan speed registers below 200 RPM or over 2100 RPM for an extended period of time, the unit ceases operation. The corresponding error code will be displayed on the indoor unit.

##### Inverter module protection

The inverter module has an automatic shut-off mechanism based on the current of the unit, voltage and temperature. If the automatic shut-off is initiated, the corresponding error code will be displayed on the indoor unit and the unit ceases operation.

##### Indoor fan delayed operation

- When the unit starts, the louver is automatically activated and the indoor fan will operate after a period of setting time or the louver is in place.
- If the unit is in heating mode, the indoor fan is regulated by the anti-cold air function.

##### Compressor pre-heating

Pre-heating is automatically activated when the T4 temperature sensor is lower than the set temperature.

##### Sensor redundancy and automatic shut-off

- If one temperature sensor malfunctions, the unit continues operation and displays the corresponding error code, allowing for emergency use.
- If more than one temperature sensor is malfunctioning, the unit ceases operation.

### 3.3 Operating functions

#### Abbreviations

Abbreviation	Element
T1	Indoor room temperature
T2	Coil temperature of the evaporator
T3	Coil temperature of the condenser
T4	Outdoor ambient temperature
Tsc	Adjusted set temperature
TP	Compressor discharge temperature
CDIFTEMP	Cooling shut-down temperature
HDFITEMP2	Heating shut-down temperature
TDC1	Enter defrost temperature
TCDE1	Exit defrost temperature 1
TCDE2	Exit defrost temperature 2 (maintained for a period of time)
TIMING_DEFROST_TIME	Enter defrost time

Table 7 Element abbreviations

The functions CDIFTEMP, HDFITEMP2, **TDC1**, TCDE1, TCDE2 and TIMING\_DEFROST\_TIME are set parameters of EEPROM.

#### 3.3.1 Fan mode

When the fan mode is activated:

- The outdoor fan and compressor cease operations;
- The temperature control is disabled and the indoor room temperature is displayed.
- The indoor fan speed can be set to 1...100% or to auto.
- The louver operations are identical to those in cooling mode.
- Auto fan: in fan-only mode, the unit operates the same as the auto fan in cooling mode with the temperature set at 24 °C.

**3.3.2 Automatic mode**

In automatic mode, the unit automatically switches between heating, cooling, dry or fan-only mode based on T1, Ts and T4 to maintain the desired temperature.

- This mode can be selected with the remote controller and the temperature can be set between 16...30 °C.
- If the setting temperature is modified, the machine selects a new running function.

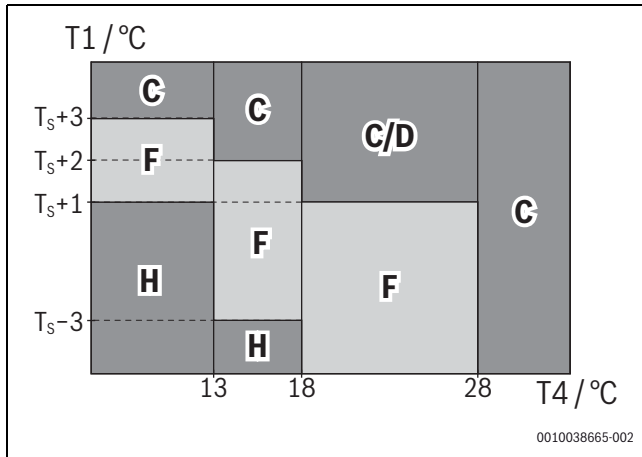

Fig. 10

- C Cooling mode
- D Dry mode if relative humidity is higher than 85%
- F Fan mode
- H Heating mode
- T1 Indoor room temperature
- T4 Outdoor ambient temperature
- Ts Set temperature

**3.3.3 Cooling mode**

**Compressor control**

While trying to reach the set temperature:

- When the compressor runs continuously for up to 120 minutes and the following conditions are satisfied, the compressor ceases operation:
  - Calculated frequency ( $F_b$ ) is less than minimum limit frequency ( $F_{min} = 12 \text{ Hz}$ ).
  - Compressor runs at  $F_{min}$  for more than 10 minutes.
  - $T1 \leq (T_s - 2.5^\circ\text{C})$ .
- When the compressor runs continuously for more than 120 minutes and the following conditions are satisfied, the compressor ceases operation:
  - Calculated frequency ( $F_b$ ) is less than minimum limit frequency ( $F_{min} = 12 \text{ Hz}$ ).
  - Compressor runs at  $F_{min}$  for more than 10 minutes.
  - $T1 \leq (T_s - 2^\circ\text{C})$ .
- If one of the following conditions is satisfied, the measures above will not be considered.
  - Compressor running frequency ( $F_r$ ) > test frequency ( $F_T$ ).
  - Compressor running frequency = test frequency and  $T4 > 15^\circ\text{C}$  or T4 error.
  - When the set temperature is changed.
  - Turbo or sleep function switched on/off.
  - Various frequency limit shut-downs occurred.

**Indoor fan control**

In cooling mode, the indoor fan operates continuously. The fan speed can be set to 1...100 % or to automatic mode. In auto fan mode the following tables apply.

T1-Ts [ °C] drops below value	Fan Speed decreases to value
≤ 3.5	80%
≤ 1	60%
≤ 0.5	40%
≤ 0	20%
≤ -0.5	1%

Table 8 Fan speed in auto fan mode

T1-Ts [ °C] rises above value	Fan Speed increases to value
> 0	20%
> 0.5	40%
> 1	60%
> 1.5	80%
> 4	100%

Table 9 Fan speed in auto fan mode

**Outdoor fan control**

- The outdoor unit will run at a different fan speed according to T4 and compressor running frequency.
- The fan speeds are different for different outdoor units.

**Condenser overheating protection**

When the condenser temperature exceeds a configured value, the compressor ceases operation.

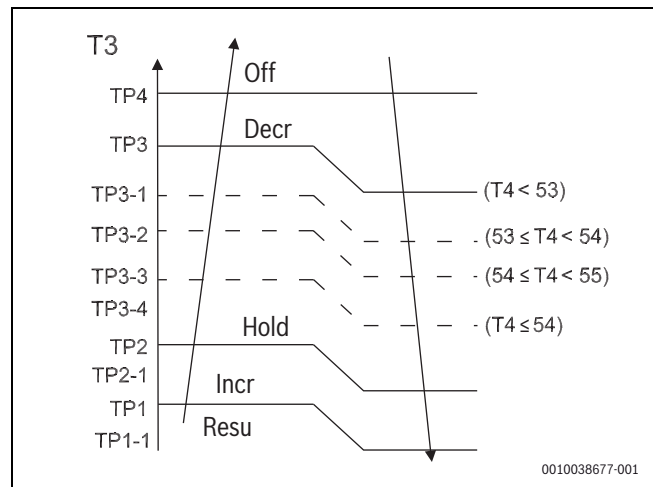

Fig. 11 Condenser temperature protection

- Off Compressor turns off
- Decr Compressor decreases performance
- Hold Compressor holds current performance
- Incr Compressor increases performance
- Resu Compressor resumes without limitation to performance
- TP Compressor discharge temperature
- T3 Coil temperature of condenser

**Evaporator low temperature protection**

If the coil temperature of the evaporator T2 falls below 4 °C, the compressor decreases the running frequency to the next lower level every 1 minute.

- If T2 decreases further below 0 °C, the compressor turns off.
- If T2 increases above 4 °C, the compressor keeps the current frequency.
- If T2 increases above 7 °C, the compressor resumes without frequency limitation.

### 3.3.4 Heating mode

#### Compressor control

While trying to reach the set temperature:

- If the following conditions are satisfied, the compressor ceases operation.
  - Calculated frequency ( $F_b$ ) is less than the minimum limit frequency ( $F_{min} = 12 \text{ Hz}$ ).
  - Compressor runs at  $F_{min}$  more than 10 minutes.
  - $T1 \geq T_S + 2^\circ\text{C}$
- If one of the following conditions is satisfied, the protective time will not be considered.
  - Compressor running frequency ( $F_r$ ) is more than test frequency ( $F_T$ ).
  - When compressor running frequency = test frequency,  $T4 \geq 15^\circ\text{C}$  or  $T4$  error.
  - When the set temperature is changed.
  - Turbo or sleep function switched on/off.
- When the current is higher than the predefined safety limit, current protection will be activated and the compressor will stop.

#### Indoor fan control

In heating mode, the indoor fan operates continuously. The fan speed can be set between 1...100 %. Anti-cold air function has priority.

**Anti-cold air function:** The indoor fan is controlled by the indoor temperature  $T1$  and the indoor unit coil temperature  $T2$ .

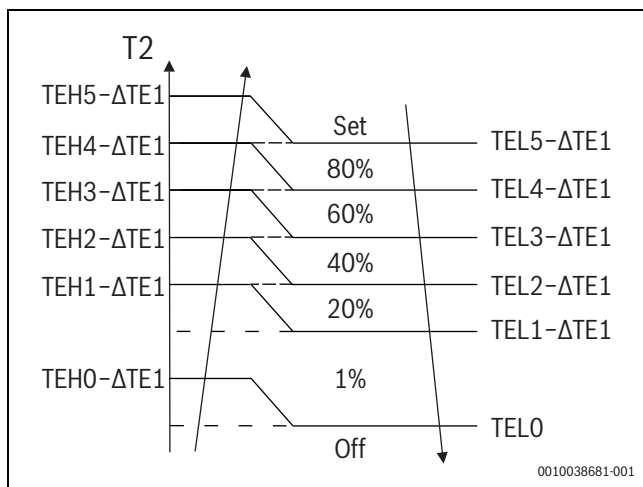

Fig. 12 Anti-cold air function

- Off Compressor turns off
- Set Set fan speed
- TEH.. Evaporator coil temperature (rising)
- TEL.. Evaporator coil temperature (decreasing)
- T2 Indoor unit coil temperature

T1 [ °C ]	ΔTE1 [ °C ]
≥ 19	0
≥ 15 and < 19	19 - T1 = 0...4
< 15	4

Table 10

In auto fan mode the following tables apply:

T1-T <sub>S</sub> [ °C ] drops below value	Fan speed increases to value
≤ 0.5	40%
≤ 0	60%
≤ -1.5	80%
≤ -3	100%

Table 11 Fan speed in auto fan mode

T1-T <sub>S</sub> [ °C ] rises above value	Fan speed decreases to value
> -1.5	80%
> 0	60%
> 0.5	40%
> 1	20%

Table 12 Fan speed in auto fan mode

#### Outdoor fan control

- The outdoor unit will be run at different fan speed according to  $T4$  and compressor running frequency.
- The fan speeds are different for different outdoor units.

#### Defrosting mode

- The unit enters defrosting mode according to changes in the temperature value of  $T3$ ,  $T4$  and the compressor running time.
- In defrosting mode, the compressor continues to run, the indoor and outdoor motor will cease operation and the defrost light of the indoor unit will turn on. In the display, **df** is displayed.
- In heating mode, if any of the following conditions is satisfied, defrosting ends and the machine switches to normal:
  - $T3$  rises above  $TCDE1^\circ\text{C}$
  - $T3$  stays above  $TCDE2^\circ\text{C}$  for 80 seconds.
  - Unit runs for 15 minutes consecutively in defrosting mode.
- If  $T4$  is lower than or equal to  $-22^\circ\text{C}$  and compressor running time is more than  $TIMING\_DEFROST\_TIME$ , defrosting starts. The unit returns to the normal heating mode if the following conditions are satisfied:
  - Unit runs for 10 minutes consecutively in defrosting mode.
  - $T3$  rises above  $10^\circ\text{C}$ .

Defrosting mode ends and the unit returns to the normal heating mode if one of the following conditions is satisfied:

- If  $T3$  is higher than  $TCDE1 + 4^\circ\text{C}$
- $T3$  is maintained above  $TCDE2 + 4^\circ\text{C}$  for 80 seconds.
- The unit runs for 15 minutes consecutively in defrosting mode.

#### Evaporator temperature protection

If the coil temperature of the evaporator  $T2$  rises above  $52^\circ\text{C}$ , the compressor reacts as follows:

- Between  $52^\circ\text{C}$  and  $55.9^\circ\text{C}$  the compressor holds the current frequency.
- Between  $56^\circ\text{C}$  and  $60^\circ\text{C}$ , the compressor decreases the running frequency to the next lower level every 20 seconds.
- Above  $60^\circ\text{C}$  the compressor turns off.
- Below  $52^\circ\text{C}$  the compressor runs without limitation.

#### 3.3.5 Dry mode

If the room temperature is lower than  $10^\circ\text{C}$ , the compressor ceases operations and does not resume until room temperature exceeds  $12^\circ\text{C}$ .

- In dry mode, the unit operates the same as auto fan in cooling mode.
- All protections are activated and operate the same as in cooling mode.
- Low room temperature protection.

#### 3.3.6 Forced operation function

##### Forced cooling mode

The compressor and outdoor fan continue to run (fixed at a rated frequency), and the indoor fan runs at rated speed. After running for 30 minutes, the unit will switch to auto mode with a set temperature of  $24^\circ\text{C}$ .

##### Forced auto mode

Forced auto mode operates the same as normal auto mode with a set temperature of  $24^\circ\text{C}$ .

### Exiting forced operation

The unit exits forced operation when it receives the following signals:

- ▶ Switch on/off
- ▶ Timer on/off
- ▶ Sleep mode
- ▶ Follow me
- ▶ Mode, fan speed or temperature settings are changed

### Forced defrosting mode

- ▶ To enter forced defrosting, press the **AUTO/COOL** button for 5 seconds when in forced cooling mode.
- ▶ The indoor fan will stop and defrosting lamp will light up.
- ▶ To quit this mode:
  - Quit normal defrosting.
  - Turn off by remote control.
  - Press **AUTO/COOL** button again for 5 seconds.

### 3.3.7 Timer function

- Timing range is 24 hours.
- Timer on: When set, the unit will turn on automatically when reaching the set time.
- Timer off: When set, the unit will turn off automatically when reaching the set time.
- Timer on/off: the machine will turn automatically when reaching the set “on” time and then turn off automatically when reaching the set “off” time.
- Timer off/on: The unit will turn off automatically when reaching the set “off” time, and then turn on automatically when reaching the set “on” time.
- The timer function will not change the unit current operation mode.
  - If the unit is currently off, it will not start automatically after setting the “timer off” function.
  - When reaching the set time, the LED will be off. The unit running mode has not been changed
- The set time is a relative time.
- The unit will exit the timer function when a malfunction is detected.



Setting the timer will not change the operating mode. In case of a malfunction, timer settings are obsolete.

### 3.3.8 Sleep mode

The sleep function is available in cooling, heating or auto mode.

The operational process for sleep mode is as follows:

- When cooling, the temperature rises 1 °C (max. 30 °C) every hour. After 2 hours, the temperature stops rising and the indoor fan is fixed at low speed.
- When heating, the temperature decreases 1 °C (min. 16 °C) every hour. After 2 hours, the temperature stops decreasing and the indoor fan is fixed at low speed. Anti-cold air function takes priority.
- The unit exits this mode after 8 hours.



The timer can be set in this mode.

### 3.3.9 Follow Me function

- Once active, the remote control will send a soundless signal every 3 minutes to the unit. The unit automatically sets the temperature according to the measurements taken by the remote control.
- The unit will only change modes if the information given by the remote controller make it necessary.

### 3.3.10 Auto-restart function

The indoor unit has an auto-restart module which allows the unit to restart automatically. The module stores the current settings and, in case of a sudden power failure, will restore those settings automatically within 3 minutes after return of power.

If there is a power failure while the unit is running, the compressor starts 3 minutes after the unit restarts. If the unit was off before the power failure, the unit stands by.

### 3.3.11 Frost protection (8 °C heating)

When the unit is operating in heating mode with a set temperature of 16 °C, press the temperature down button twice in one second to choose one of the operation modes:

- 8 °C heating
- 12 °C heating
- Previous heating mode.

To quit this function:

- ▶ Switch the unit on/off
- ▶ Enter sleep mode
- ▶ Set mode
- ▶ Adjust the set temperature or fan speed.

### 3.3.12 Silent function

To enable the Silent function:

- ▶ Press the “Silence” button;
- ▶ Press the fan button for more than two seconds on the remote control

While this function is enabled, the indoor unit will blow a slight breeze (1% of the fan speed), reducing the noise to the lowest level possible.

### 3.3.13 iClean 56°C

The iClean 56°C Technology freezes dust, mould and grease that may adhere to the evaporator. Everything is then quickly defrosted and dried with hot air. This operation is used to produce more condensed water to improve the cleaning effect. Cold air will be blown out. After cleaning, the internal fan keeps operation with hot air to dry the evaporator, maintaining the inside of the unit clean.

When this function is turned on, the indoor unit display shows **CL**. After 20 to 130 minutes, the unit will turn off automatically and exit this function.

### 3.3.14 Energy saving function

To select the energy saving function:

- ▶ Press the iECO/Gear button on the remote controller to select one of the following modes:
  - 75%: reduces power consumption by 25%
  - 50%: reduces power consumption by 50%
  - Set the previous mode.

To exit this function:

- ▶ Turn off the unit.
- ▶ Enable the ECO, sleep, cooling, silence or iClean 56°C function.

### 3.3.15 Radar detection function

The unit has a radar system that can detect the activity of persons in the room. In cooling and heating mode, if there is no one in the room for 30 minutes, the unit automatically lowers the frequency to save energy.

- Transmission frequency: 5725 – 5875 MHz
- Maximum transmission power: < 0dBm
- Detectable area of the radar:
  - 1 m directly below the unit;
  - An area of 6 m in front of the unit.

To activate the function:

- ▶ Press the radar button on the remote controller while the unit is one.



---

This function can only be activated using the remote controller and is only available in heating or cooling mode.

---

The radar identifies any moving objects in a room as human activity. Indoor movements of vacuuming robots, fans, plants or curtains will activate this function, which may result in no power saving.

A lot of metal in the surfaces of the room will produce a strong reflection of electromagnetic waves, which may result in no power saving.

### 3.3.16 Wireless control function

This function allows the control of the unit using a mobile phone and a wireless connection. USB device access, replacement and maintenance operations must be carried out by a professional.

## 4 Refrigerant

### 4.1 First time installation check

Air and moisture trapped in the refrigerant system affects the performance of the air conditioner by:

- Increasing pressure in the system
- Increasing the operating current
- Decreasing the cooling or heating efficiency
- Congesting the capillary tubing due to ice build-up in the refrigerant circuit
- Corroding the refrigerant system

To prevent air and moisture from affecting the performance of the unit, the indoor unit, as well as the pipes between the indoor and outdoor unit, must be leak tested and evacuated.

#### Leak test (soap water method)

- ▶ Use a soft brush to apply soapy water or a natural liquid detergent on both the indoor and outdoor unit connections. Bubbles will form on the connection if there is a gas leakage.

#### Air purging with vacuum pump

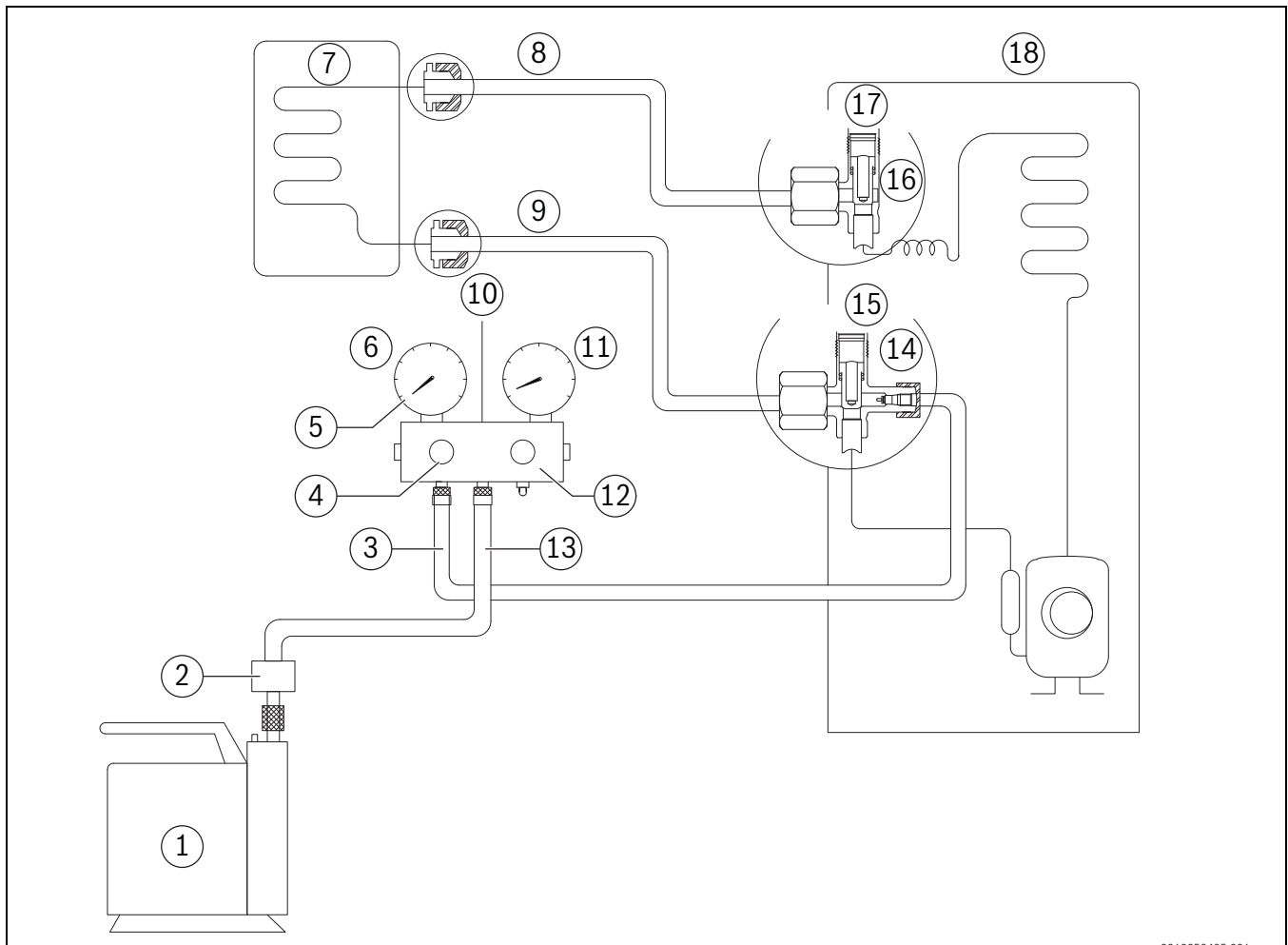
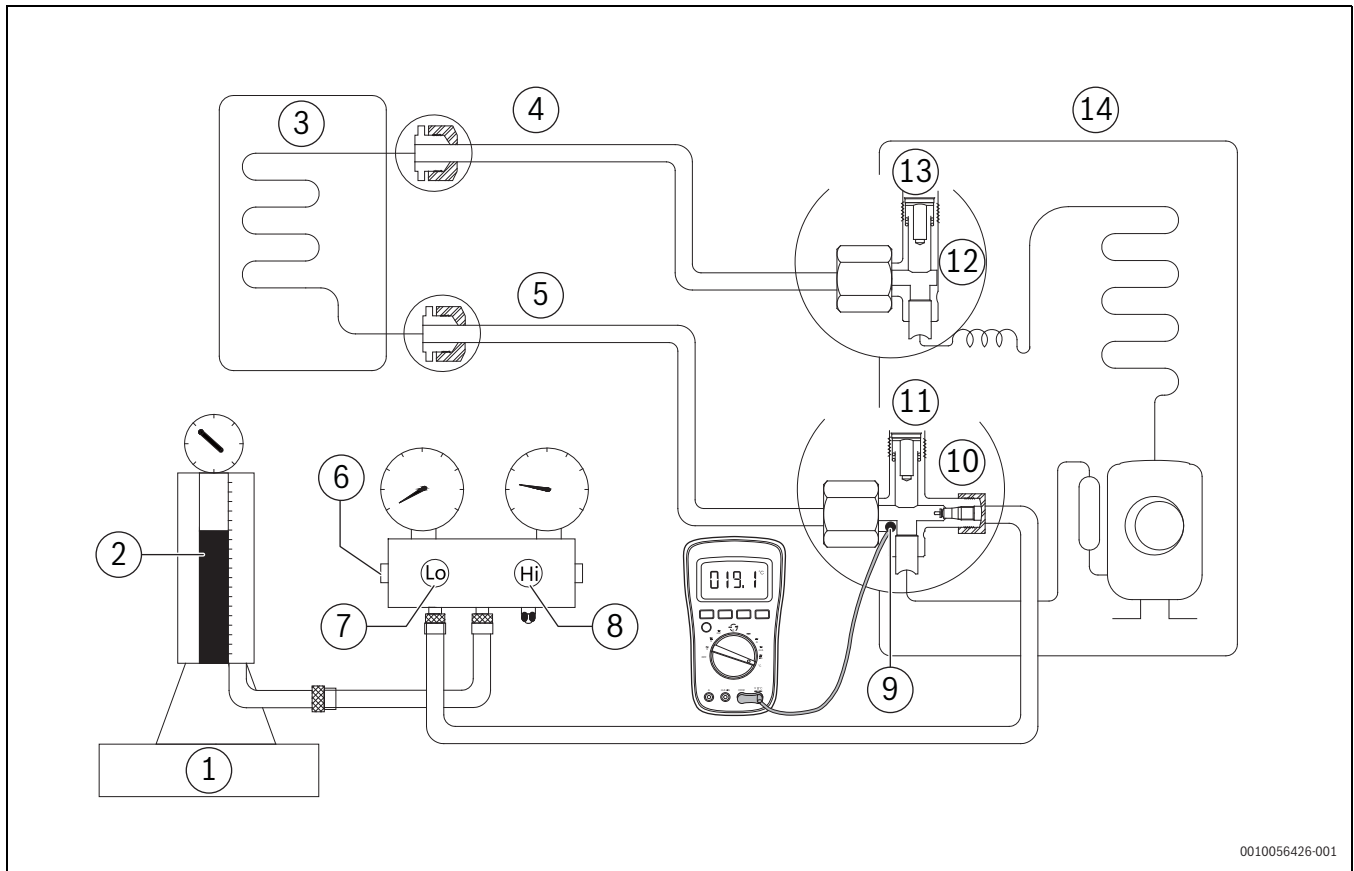

Fig. 13 Air purging with vacuum pump

- |                                     |                                       |
|-------------------------------------|---------------------------------------|
| [1] Vacuum pump                     | [10] Manifold valve                   |
| [2] Vacuum pump                     | [11] Pressure gauge                   |
| [3] Charge hose                     | [12] Handle Hi (high pressure handle) |
| [4] Handle Lo (low pressure handle) | [13] Charge hose                      |
| [5] -0.1 MPa                        | [14] Close                            |
| [6] Compound meter                  | [15] Gas valve                        |
| [7] Indoor unit                     | [16] Close                            |
| [8] Liquid side                     | [17] Liquid valve                     |
| [9] Gas side                        | [18] Outdoor unit                     |

1. Tighten the flare nuts of the indoor and outdoor units.
2. Confirm that both the liquid and gas valves are closed.
3. Connect the charge hose of the low pressure handle to the service port of the gas valve.
4. Connect another charge hose to the vacuum pump.
5. Fully open the manifold valve of the low pressure handle.
6. Using the vacuum pump, evacuate the system for 30 minutes.
7. Check whether the compound meter indicates  $-0.1$  MPa (14.5 Psi).
  - If the meter does not indicate  $-0.1$  MPa (14.5 Psi) after 30 minutes, continue evacuating for an additional 20 minutes.
  - If the pressure does not achieve  $-0.1$  MPa (14.5 Psi) after 50 minutes, check for leakage.
  - If the pressure successfully reaches  $-0.1$  MPa (14.5 Psi), fully close the low pressure handle valve, then cease vacuum pump operations.
8. Wait for 5 minutes.
9. Check whether the gauge needle moves after turning off the vacuum pump. If the gauge needle moves backwards, check for gas leakage.
10. Loosen the flare nut of the gas valve for 6/7 seconds.
11. Tighten the flare nut again.
12. Confirm that the pressure display in the pressure indicator is slightly higher than the atmospheric pressure.
13. Remove the charge hose from the gas valve.
14. Fully open the liquid and gas valves.
15. Tighten the cap of the liquid and gas valves.

**4.2 Refrigerant recharge**



0010056426-001

Fig. 14 Refrigerant recharge

- [1] Electronic scale
- [2] Charging cylinder
- [3] Indoor unit
- [4] Liquid side
- [5] Gas side
- [6] Check valve
- [7] Open
- [8] Close
- [9] Temperature sensor
- [10] Open
- [11] Gas valve
- [12] Open
- [13] Liquid valve
- [14] Outdoor unit

1. Close the gas and the liquid valves.
2. Connect the charge hose between the low pressure handle to the service port of the gas valve.
3. Connect the charge hose to the valve on the bottom of the charging cylinder.
4. If necessary, invert the charging cylinder to ensure a complete liquid charge.
5. Open the valve on the bottom of the charging cylinder for 5 seconds to purge the air in the charge hose.
6. Tighten the charge hose between the low pressure handle and the service port of the gas valve.
7. Place the refrigerant bottle onto an electronic scale and record the starting weight.
8. Fully open the manifold valve of the low pressure handle, gas valve and liquid valve.
9. Operate the unit in cooling mode to charge the system with liquid refrigerant.
10. Slowly open the refrigerant bottle valve to charge the required amount of refrigerant.

11. When the electronic scale displays the correct weight<sup>1)</sup>, turn off the unit and disconnect the charge hose from the gas valve.
12. Mount the caps of the service port, gas and liquid valves.
13. Use a torque wrench to tighten the caps to a torque of 18 Nm.
14. Check for gas leakage.

1) Confirm by checking the gauge and the pressure of the low pressure handle side. Refer to 7.3 for pressure values.

## 4.3 Re-Installation

### 4.3.1 Indoor unit

#### Collecting the refrigerant into the outdoor unit

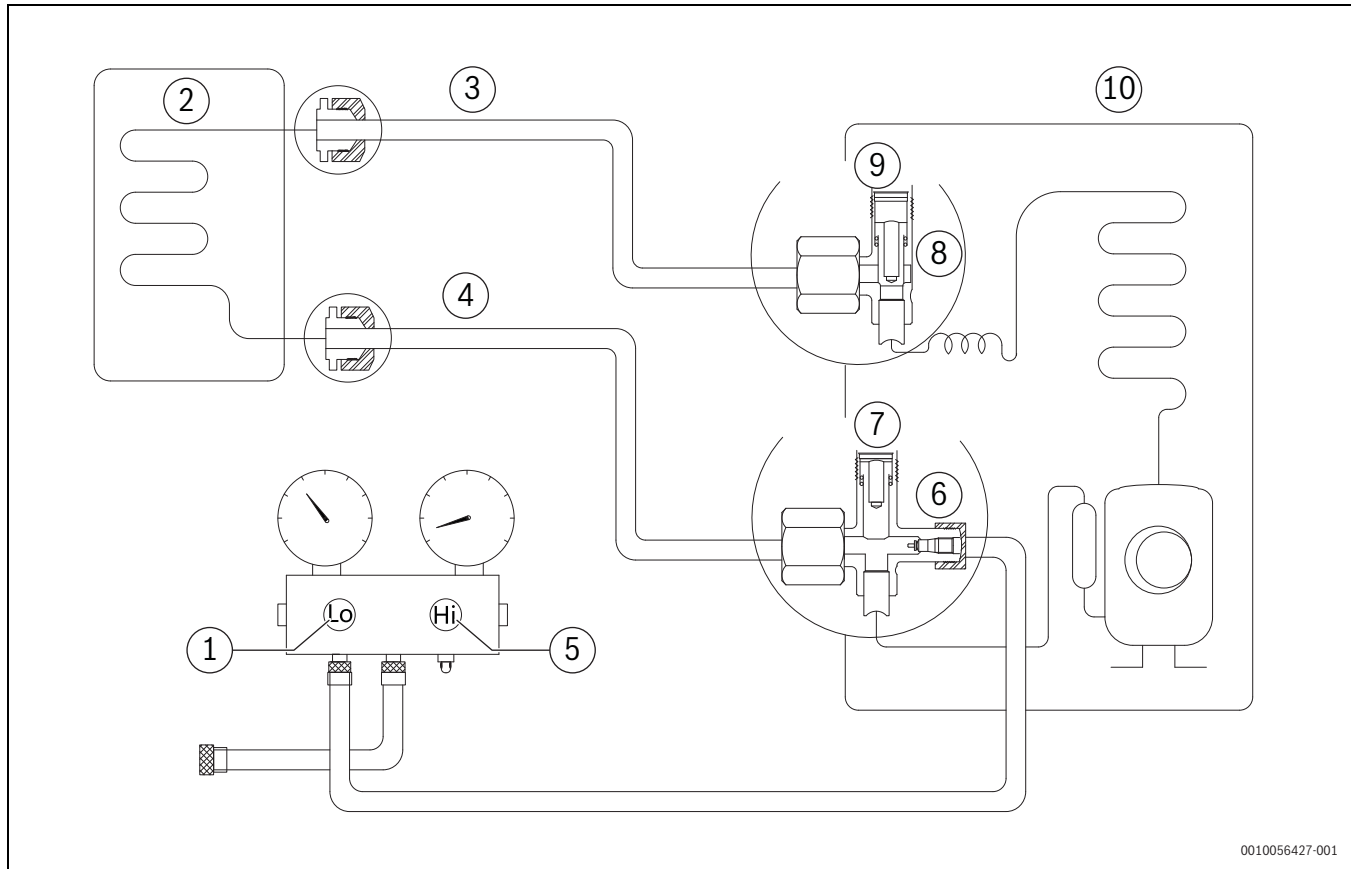
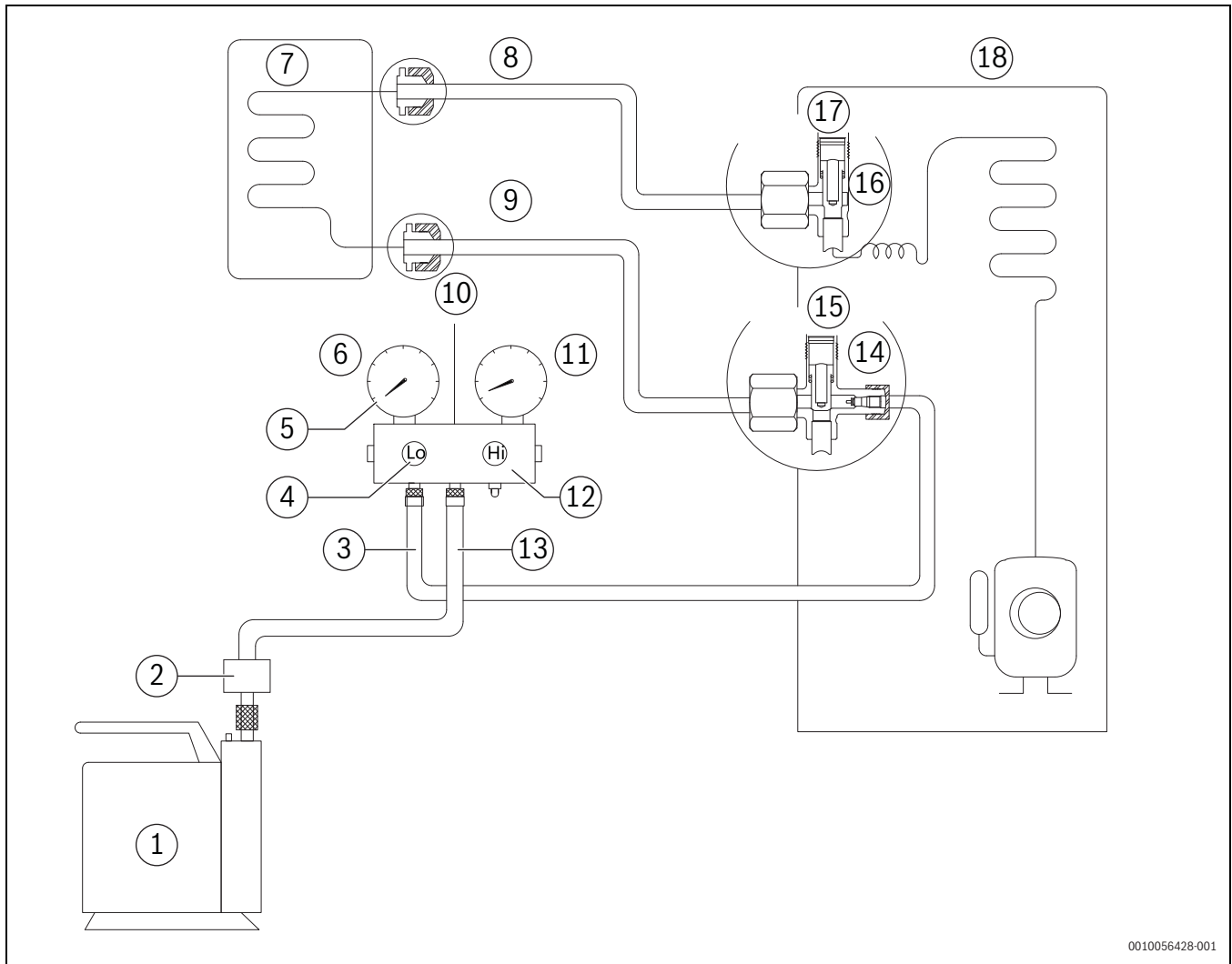

Fig. 15 Collecting the refrigerant into the outdoor unit

- [1] Close
- [2] Indoor unit
- [3] Liquid side
- [4] Gas side
- [5] Close
- [6] Open
- [7] Gas valve
- [8] Close
- [9] Liquid valve
- [10] Outdoor unit

1. Confirm that the liquid and gas valves are open.
2. Connect the charge hose with the low pressure handle to the service port of the gas valve.
3. Open the manifold valve of the low pressure handle to purge air from the charge hose for 5 seconds and then close it quickly.
4. Close the liquid valve.
5. Operate the unit in cooling mode.
6. Cease operations when the gauge reaches 0.1 MPa (14.5 Psi).
7. Close the gas valve so that the gauge rests between 0.3 MPa (43.5 Psi) and 0.5 MPa (72.5 Psi).
8. Disconnect the charge set and mount the caps of the service port and liquid and gas valves.
9. Use a torque wrench to tighten the caps to a torque of 18 Nm.
10. Check for a gas leakage.

**Air purging with vacuum pump**



0010056428-001

Fig. 16 Air purging with vacuum pump

- [1] Vacuum pump
  - [2] Vacuum pump
  - [3] Charge hose
  - [4] Handle Lo (low pressure handle)
  - [5] -0.1 MPa
  - [6] Compound meter
  - [7] Indoor unit
  - [8] Liquid side
  - [9] Gas side
  - [10] Manifold valve
  - [11] Pressure gauge
  - [12] Handle Hi (high pressure handle)
  - [13] Charge hose
  - [14] Close
  - [15] Gas valve
  - [16] Close
  - [17] Liquid valve
  - [18] Outdoor unit
1. Tighten the flare nuts of the indoor and outdoor units.
  2. Confirm that both the liquid and gas valves are closed.
  3. Connect the charge hose of the low pressure handle to the service port of the gas valve.
  4. Connect another charge hose to the vacuum pump.
  5. Fully open the manifold valve of the low pressure handle.
  6. Using the vacuum pump, evacuate the system for 30 minutes.
  7. Check whether the compound meter indicates -0.1 MPa (14.5 Psi).
    - If the meter does not indicate -0.1 MPa (14.5 Psi) after 30 minutes, continue evacuating for an additional 20 minutes.
    - If the pressure does not achieve -0.1 MPa (14.5 Psi) after 50 minutes, check for a leakage.
    - If the pressure successfully reaches -0.1 MPa (14.5 Psi), fully close the low pressure valve, then cease vacuum pump operations.
  8. Wait for 5 minutes then check whether the gauge needle moves after turning off the vacuum pump.
  9. Check whether the gauge needle moves after turning off the vacuum pump. If the gauge needle moves backwards, check for gas leakage.
  10. Loosen the flare nut of the gas valve for 6/7 seconds.
  11. Tighten the flare nut again.
  12. Confirm that the pressure display in the pressure indicator is slightly higher than the atmospheric pressure.
  13. Remove the charge hose from the gas valve.
  14. Fully open the liquid and gas valves.
  15. Tighten the cap of the liquid and gas valves.

### 4.3.2 Outdoor unit

#### Evacuation for the whole system

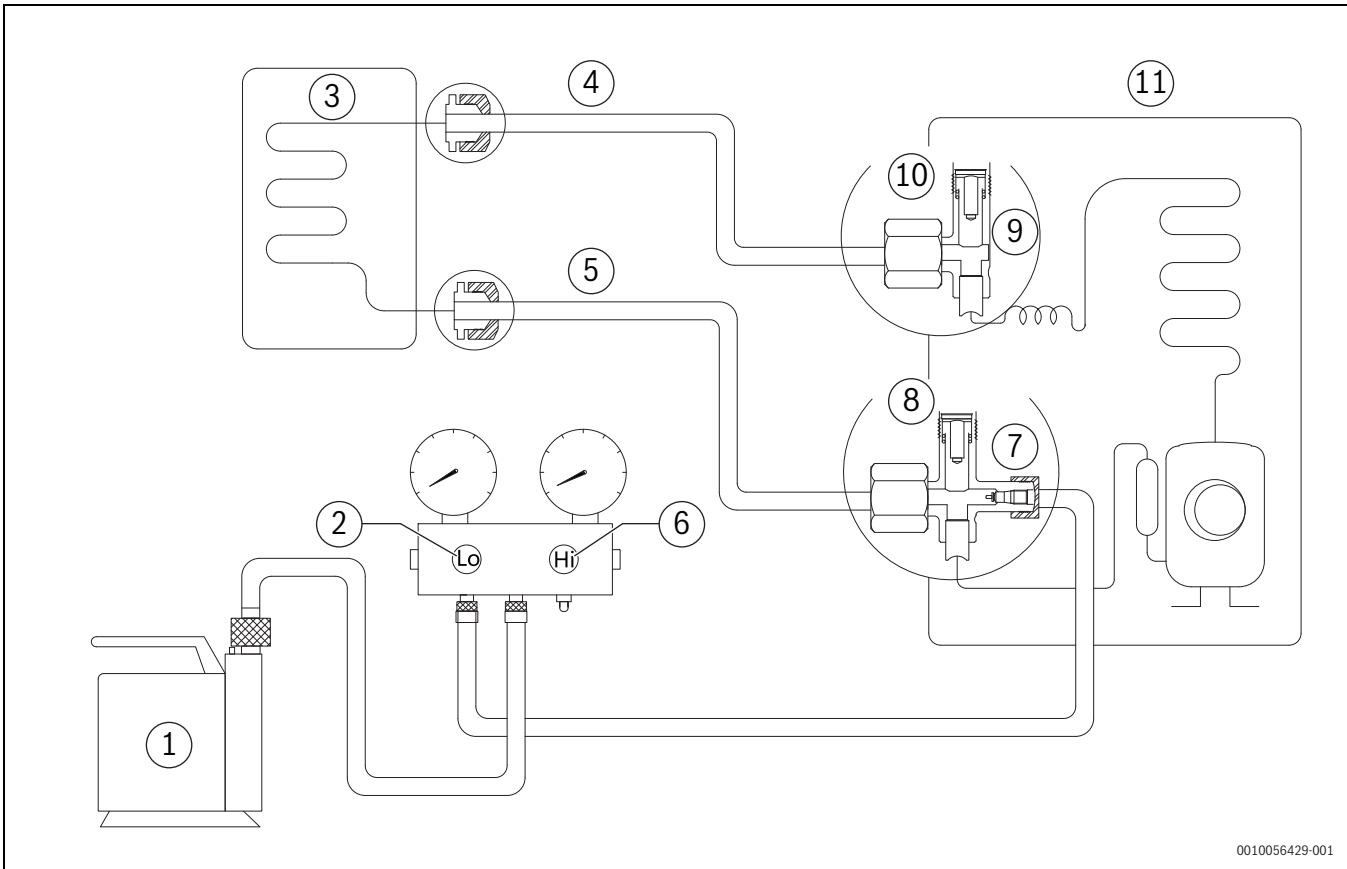

0010056429-001

Fig. 17 Evacuation for the whole system

- [1] Vacuum pump
- [2] Open
- [3] Indoor unit
- [4] Liquid side
- [5] Gas side
- [6] Close
- [7] Open
- [8] Gas valve
- [9] Open
- [10] Liquid valve
- [11] Outdoor unit

1. Confirm that the liquid and gas valves are open.
2. Connect the vacuum pump to the service port of the gas valve.
3. Evacuate the system for approximately one hour.
4. Confirm that the compound meter indicates  $-0.1$  MPa (14.5 Psi).
5. Close the valve (Handle Lo) on the charge set.
6. Turn off the vacuum pump.
7. Wait for 5 minutes.
8. Check whether the gauge needle moves after turning off the vacuum pump.
9. If the gauge needle moves backward, check whether there is a gas leakage.
10. Disconnect the charge hose from the vacuum pump.
11. Mount the caps of the service port and of the liquid and gas valves.
12. Use a torque wrench to tighten the caps to a torque of 18 Nm.

**Refrigerant charging**

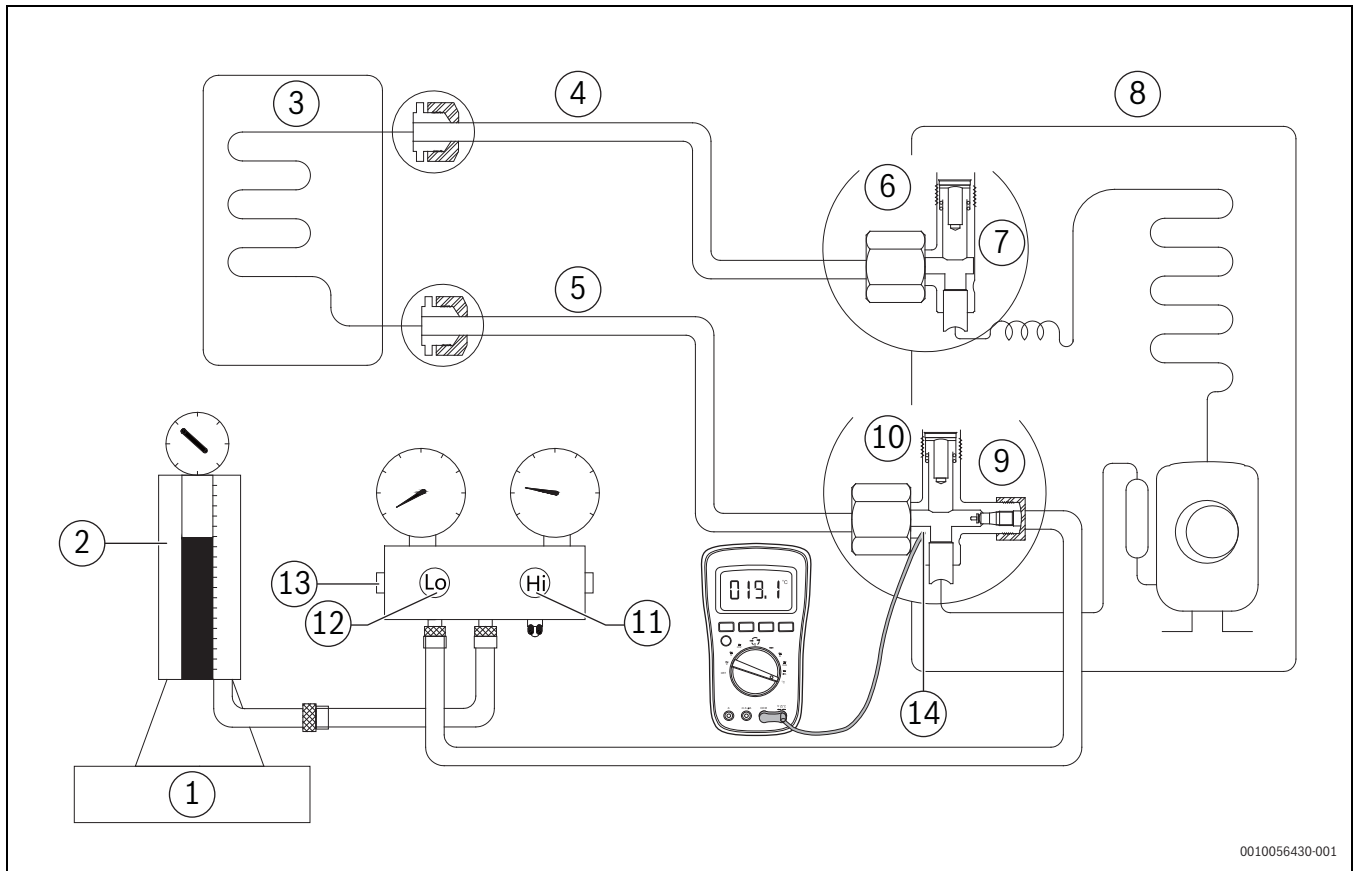

0010056430-001

Fig. 18 Refrigerant charging

- [1] Electronic scale
- [2] Charging cylinder
- [3] Indoor unit
- [4] Liquid side
- [5] Gas side
- [6] Liquid valve
- [7] Open
- [8] Outdoor unit
- [9] Open
- [10] Gas valve
- [11] Close
- [12] Open
- [13] Check valve
- [14] Temperature sensor

1. Close the gas and the liquid valves.
2. Connect the charge hose between the low pressure handle to the service port of the gas valve.
3. Connect the charge hose to the valve on the bottom of the charging cylinder.
4. If necessary, invert the charging cylinder to ensure a complete liquid charge.
5. Open the valve on the bottom of the charging cylinder for 5 seconds to purge the air in the charge hose.
6. Tighten the charge hose between the low pressure handle and the service port of the gas valve.
7. Place the refrigerant bottle onto an electronic scale and record the starting weight.
8. Fully open the manifold valve of the low pressure handle, gas valve and liquid valve.
9. Operate the unit in cooling mode to charge the system with liquid refrigerant.
10. When the electronic scale displays the correct weight<sup>1)</sup>, turn off the unit and disconnect the charge hose from the gas valve.

11. Mount the caps of the service port, gas and liquid valves.
12. Use a torque wrench to tighten the caps to a torque of 18 Nm.
13. Check for gas leakage.



Mechanical connectors used indoors shall comply with local regulations. When mechanical connectors are reused indoors, sealing parts shall be renewed. When flared joints are reused indoors, the flare part shall be re-fabricated.

1) Confirm by checking the gauge and the pressure of the low pressure handle side. Refer to 7.3 for pressure values.

## 5 Diagnosis and troubleshooting

### 5.1 Safety precautions

All electrical work must be carried out by competent and suitably qualified, certified and accredited professionals and in accordance with all applicable legislation (all national, local and other laws, standards, codes, rules, regulations and other legislation that may apply).



#### WARNING

- ▶ Power-off all units before connecting or disconnecting any connections or wiring. Otherwise electric shock may occur, leading to damage to components, physical injury or death.
- ▶ Electricity remains in capacitors even when the power supply is off. Ensure the capacitors are fully discharged before troubleshooting.

#### NOTICE

##### Risk of static discharge.

Static charges can destroy sensitive electronics parts.

- ▶ Wear antistatic gloves.

Test the voltage between P and N on back of the main PCB with multimeter. If the voltage is lower than 36V, the capacitors are fully discharged.

For models that cannot be measured, wait 5 minutes after the power supply is off to make sure that the capacitors are fully discharged.

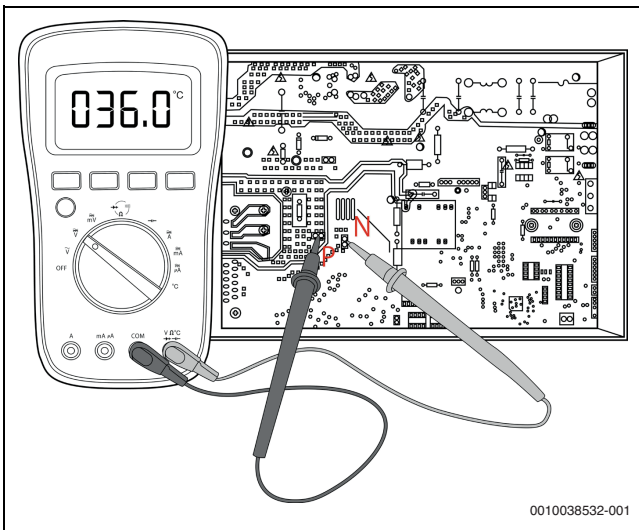

Fig. 19 Voltage test



Figures are for reference only. The actual appearance of the unit appearance may vary.

## 5.2 General troubleshooting

### Error display (Indoor unit)

An error code will be shown on the display when the indoor unit identifies an error.

#### For other errors:

The display board may show an unclear or undefined code by the service manual.

- ▶ Make sure that this code is not a temperature reading.

### Troubleshooting

If no error code is shown:

- ▶ Test the unit using the remote control.
- ▶ If the unit does not respond to the remote, replace the PCB.
- ▶ If the unit responds, replace the display board.

## 5.3 Record Form

Request No.:

Date:

Installation Date:

Service Date:

Customer Information			
Name		Telephone No.	
Home address			
Email			
Product Information			
Indoor unit model		Outdoor unit model	
Serial No. of indoor unit			
Serial No. of outdoor unit			
Working mode	<input type="checkbox"/> Cooling <input type="checkbox"/> Heating	<input type="checkbox"/> Fan only <input type="checkbox"/> Dry	
Set temperature	_____ °C	Fan speed	<input type="checkbox"/> Turbo <input type="checkbox"/> High <input type="checkbox"/> Medium <input type="checkbox"/> Low <input type="checkbox"/> Auto
Temperature of the air inlet	_____ °C	Temperature of air the outlet	_____ °C
Installation/Condition Information			
Indoor temperature	_____ °C	Indoor humidity	_____ %RH
Outdoor temperature	_____ °C	Outdoor humidity	_____ %RH
Length of connecting pipe		Pipe diameter	Gas pipe:      Liquid pipe:
Length of wiring		Wire diameter	
System running pressure	_____ MPa      or      _____ Bar      or      _____ PSI		
Room size (L × W × H)			
Photo of installation of indoor unit (Photo #1)		Photo of installation of outdoor unit (Photo #2)	
Failure Description			
Error code of indoor unit		Code of outdoor PCB	
Unit does not start			
Remote control does not work			
Indoor display shows nothing			
No cooling or heating			
Less cooling or heating			
Unit starts but stops shortly			
High noise			
High vibration			

## 5.4 Query

### Error codes

Code	Error
EC 07	The outdoor fan speed is operating outside of the normal range
EC 51	Outdoor unit EEPROM parameter error
EC 52	Condenser coil temperature sensor T3 is in open/short circuit
EC 53	Outdoor room temperature sensor T4 is in open/short circuit
EC 54	Compressor discharge temperature sensor TP is in open/short circuit
EC 71	Outdoor external fan over-voltage error
EC 72	Outdoor external fan phase failure
EC 73	Zero speed error of the outdoor unit DC fan
EC 74	Outdoor external fan current sampling bias error
EC 75	Outdoor external fan protection/hardware over-voltage protection
EH 00/EH 0A	Indoor unit EEPROM parameter error
EH 0b	Indoor PCB/display board communication error
EH bA	Communication error between the indoor unit and the indoor external fan
EH bE	Communication error between the radar and the display/radar error
EH 30	Error in the parameters of the indoor external fan
EH 35	Indoor external fan phase failure
EH 36	Indoor external fan current sampling bias error
EH 37	Indoor external fan zero speed error
EH 38	Indoor external fan stall failure
EH 39	Out of step failure of the indoor external fan
EH 3A	Low voltage protection of the indoor external fan DC bus
EH 3b	The fan DC bus voltage of the indoor external fan is too high
EH 3E	Indoor external fan over-voltage error
EH 3F	Indoor external fan/hardware over-voltage protection
EH 03	The indoor fan speed is operating outside of the normal range
EH 60	Indoor room temperature sensor T1 is in open/short circuit
EH 61	Evaporator coil temperature sensor T2 is in open/short circuit
EL 01	Indoor/outdoor unit communication error
EL 0C	Refrigerant leak detected
FH 0P	AP mode is active but there is no Wi-Fi kit installed
PC 00	IPM malfunction or IGBT over-strong current protection
PC 02	Top temperature protection of the compressor/high temperature protection of the IPM module
PC 03	Pressure protection
PC 06	Compressor discharge temperature protection
PC 08	Outdoor current protection
PC 10	Under-voltage protection
PC 11	Over-voltage protection
PC 12	DC voltage protection
PC 30	System overpressure protection
PC 31	System pressure too low protection

Code	Error
PC 40	Communication error between the outdoor main chip and the compressor driven chip
PC 41	Current input detection protection
PC 42	Compressor start error
PC 43	Lack of phase (3-phase) protection
PC 44	No speed protection
PC 45	341PWM error
PC 46	Compressor speed malfunction
PC 49	Compressor over-current protection
PC 0A	Condenser high temperature protection
PC 0F	PFC module malfunction
PC 0L	Outdoor ambient temperature too low
PH 09	Anti-cold air in heating mode
PH 90	Evaporator coil temperature too high protection
PH 91	Evaporator coil temperature too low protection
PH 0C	Failure of the humidity sensor of the indoor unit
LC 01	Frequency limit caused by T3
LC 02	Frequency limit caused by TP
LC 03	Frequency limit caused by current
LC 05	Frequency limit caused by voltage
LC 06	Frequency limit caused by PFC
LH 00	Frequency limit caused by T2
LH 07	Frequency limit caused by the remote controller
--	Conflict with the mode of the indoor units

Table 13 Error codes

## 5.5 Error diagnosis and troubleshooting without error code



### CAUTION

**A running unit can cause damage or injury.**

- ▶ Turn off the unit before any maintenance work.

### 5.5.1 Remote maintenance



When troubles occur, please check the following points with customers before field maintenance.

Problem	Type	Possible cause	Test method/solution
Unit will not start	Electrical	Power failure	▶ Test voltage.
		The main power stopped	▶ Close the power switch.
		Loose connections	▶ Inspect connections - tighten.
		Faulty transformer	▶ Change the transformer.
The power switch is on but fan does not run	Electrical	Loose connections	▶ Inspect connections - tighten.
		Faulty transformer	▶ Change the transformer.
		The voltage is too high or too low	▶ Test voltage.
The temperature on the display board cannot be set	Other	Interference from cell phone towers and remote boosters	▶ Reconnect the power or press ON/OFF button on remote control to restart operation.
The temperature on the display board cannot be set	Electrical	The remote control is powered off	▶ Replace the battery of the remote control.
		Broken remote control	▶ Replace the remote control.
Unit is on but the airflow is not cold (hot)	Refrigerant	Set temperature is too high/low	▶ Adjust the set temperature.
		Ambient temperature is too high/low	▶ Turn on the unit later.
		Fan mode is active	▶ Change to cooling/heating mode.
Unit runs, but shortly stops	Electrical	The voltage is too high or too low	▶ Test voltage.
	Refrigerant	Set temperature is too high/low	▶ Adjust the set temperature.
		Ambient temperature is too high/low	▶ Turn on the unit later.
The unit starts and stops frequently	Electrical	The voltage is too high or too low	▶ Test voltage.
	Refrigerant	Ambient temperature is too high/low	▶ Turn on the unit later.
		Frosting and defrosting frequently	▶ Turn on the unit later.
	Other	The air inlet or outlet of either unit is blocked	▶ Remove the obstacles.
Unit runs continuously but there is insufficient cooling (heating)	Refrigerant	Dirty air filter	▶ Clean or replace air filter.
		Dirty condenser fins	▶ Clean condenser fins.
		Set temperature is too high/low	▶ Adjust the set temperature.
		Ambient temperature is too high/low	▶ Turn on the unit later.
		Silence function is activated (optional function)	▶ Turn off the Silence function.
	Other	Heavy load condition	▶ Check heat load.
		Bad air proof	▶ Close all the windows and doors.
	The air inlet or outlet of either unit is blocked	▶ Remove the obstacles.	
Cooling does not change to heat			
Unit is noisy	Other	Loosen hold down bolts and / or screws	▶ Tighten bolts or screws.
		Shipping plates remain attached	▶ Remove them.

Table 14 Remote maintenance

### 5.5.2 Field maintenance

Problem	Type	Possible cause	Test method/solution
Unit will not start	Electrical	Power failure	▶ Test voltage
		Blown fuse or varistor	▶ Inspect fuse type and size
		Loose connections	▶ Inspect connections - tighten
		Shortened or broken wires	▶ Test circuits with tester
		Safety device opens	▶ Test continuity of safety device
		Faulty transformer	▶ Check control circuit with tester
Compressor will not start but the fan runs	Electrical	Shortened or broken wires	▶ Test circuits with tester
		Faulty thermostat/room temperature sensor	▶ Test continuity of thermostat/sensor and wiring
		Shortened or open capacitor	▶ Check capacitor with tester
		Faulty magnetic contactor for compressor	▶ Test continuity of coil and contacts
	Refrigerant	Shortened or grounded compressor	▶ Check resistance with multimeter
Compressor and condenser of the outdoor fan will not start	Electrical	Compressor stuck	▶ Replace the compressor
		Shortened or broken wires	▶ Test circuits with tester
		Faulty thermostat/room temperature sensor	▶ Test continuity of thermostat/sensor and wiring
Evaporator of the indoor fan will not start	Electrical	Faulty magnetic contactor for compressor	▶ Test continuity of coil and contacts
		Shortened or broken wires	▶ Test circuits with tester
		Shortened or open capacitor	▶ Check capacitor with tester
Condenser of the outdoor fan will not start	Electrical	Faulty magnetic contactor for fan	▶ Test continuity of coil and contacts
		Shortened or grounded fan motor	▶ Check resistance with multimeter
		Shortened or broken wires	▶ Test circuits with tester
		Faulty thermostat/room temperature sensor	▶ Test continuity of thermostat/sensor and wiring
		Shortened or open capacitor	▶ Check capacitor with tester
Unit runs, but shortly stops	Electrical	Faulty magnetic contactor for fan	▶ Test continuity of coil and contacts
		Low voltage	▶ Test voltage
	Refrigerant	Shortage of refrigerant	▶ Leak test
		Restricted liquid line	▶ Replace restricted part
		Overcharge of refrigerant	▶ Change charged refrigerant volume
		Dirty or partially blocked condenser	▶ Clean the condenser or remove obstacle
		Expansion valve or capillary tube closed completely	▶ Replace valve/capillary
Leaking power element on expansion valve	▶ Replace valve		
Compressor short cycling due to overload	Electrical	Faulty magnetic contactor for compressor	▶ Test continuity of coil and contacts
		Low voltage	▶ Test voltage
	Refrigerant	Shortage of refrigerant	▶ Leak test
		Overcharge of refrigerant	▶ Change charged refrigerant volume
High discharge pressure	Refrigerant	Dirty or partially blocked condenser	▶ Clean the condenser or remove obstacle
		Air or incompressible gas in refrigerant cycle	▶ Purge, evacuate and recharge
		Overcharge of refrigerant	▶ Change charged refrigerant volume
		Limitation of the condensation of the air flow	▶ Remove obstruction to the air flow
		High temperature condensing medium	▶ Remove obstruction in air or water flow
		Insufficient condensing medium	▶ Remove obstruction in air or water flow
Low discharge pressure	Refrigerant	Shortage of refrigerant	▶ Leak test
		Inefficient compressor	▶ Test the compressor efficiency

Problem	Type	Possible cause	Test method/solution
High suction pressure	Refrigerant	Overcharge of refrigerant	▶ Change charged refrigerant volume
		Inefficient compressor	▶ Test compressor efficiency
		Temperature sensor is not installed correctly	▶ Install the sensor correctly
	Other	Heavy load condition	▶ Check heat load
Low suction pressure	Refrigerant	Shortage of refrigerant	▶ Leak test
		Restricted liquid line	▶ Replace restricted part
		Dirty air filter	▶ Clean or replace
		Dirty evaporator coil	▶ Clean coil
		Insufficient air through the evaporator coil	▶ Check fan
		Expansion valve obstructed	▶ Replace valve
		Expansion valve or capillary tube closed completely	▶ Replace valve/capillary
		Leaking power element on the expansion valve	▶ Replace valve
Unit runs continuously but there is insufficient cooling	Refrigerant	Shortage of refrigerant	▶ Leak test
		Restricted liquid line	▶ Replace restricted part
		Dirty air filter	▶ Clean or replace
		Dirty evaporator coil	▶ Clean coil
		Insufficient air through the evaporator coil	▶ Check fan
		Dirty or partially blocked condenser	▶ Clean condenser or remove obstacle
		Air or incompressible gas in refrigerant cycle	▶ Purge, evacuate and recharge
		Short cycling of condensing air	▶ Remove obstruction to air flow
		Inefficient compressor	▶ Test the compressor efficiency
	Other	Heavy load condition	▶ Check heat load
	Poor choices of capacity	▶ Choose a unit with larger capacity or increase the number of units	
Too cool	Electrical	Faulty thermostat/room temperature sensor	▶ Test continuity of thermostat/sensor and wiring
		Temperature sensor installed in the wrong place	▶ Install the temperature sensor at the central of the air inlet grille
Compressor is noisy	Refrigerant	Overcharge of refrigerant	▶ Change charged refrigerant volume
		Broken compressor internal parts	▶ Replace compressor
	Other	Loosen hold down bolts and/or screws	▶ Tighten bolts or screws
		Shipping plates remain attached	▶ Remove them
Horizontal louver can not revolve	Electrical	Contact of piping with other piping or external plate	▶ Rectify piping so as not to contact each other or with external plate
		Loose connections	▶ Inspect connections - tighten
		Shortened or broken wires	▶ Test circuits with tester
		Faulty stepping motor	▶ Replace the stepping motor

Table 15 Field maintenance

### 5.6 Quick maintenance by error code

If there is no time to test which specific parts are faulty, the required parts can be directly changed according the error code.

The parts to be replaced by error code can be found in the following table.

Part requiring replacement	Error code																			
	EC 07	EC 51	EC 52	EC 53	EC 54	EC 56	EH 00/ EH 0A	EH 02	EH 03	EH 60	EH 61	EH 0b	EH bE	EL 01	EL 0C	PC 00	PC 01	PC 02	PC 03	PC 04
Indoor PCB	-	-	-	-	-	-	✓	✓	✓	✓	✓	✓	-	✓	✓	-	-	-	-	-
Outdoor PCB	✓	✓	✓	✓	✓	✓	-	-	-	-	-	-	-	✓	-	✓	✓	✓	✓	✓
Indoor fan motor	-	-	-	-	-	-	-	-	✓	-	-	-	-	-	-	-	-	-	-	-
Outdoor fan motor	✓	-	-	-	-	-	-	-	-	-	-	-	-	-	-	✓	-	✓	-	✓
T1 sensor	-	-	-	-	-	-	-	-	-	✓	-	-	-	-	-	-	-	-	-	-
T2 sensor	-	-	-	-	-	-	-	-	-	-	✓	-	-	-	✓	-	-	-	-	-
T3 sensor	-	-	✓	-	-	-	-	-	-	-	-	-	-	-	-	-	-	-	-	-
T4 sensor	-	-	-	ü	-	-	-	-	-	-	-	-	-	-	-	-	-	-	-	-
T2B sensor	-	-	-	-	-	✓	-	-	-	-	-	-	-	-	-	-	-	-	-	-
TP sensor	-	-	-	-	✓	-	-	-	-	-	-	-	-	-	-	-	-	-	-	-
Display board	-	-	-	-	-	-	-	-	-	-	-	✓	✓	-	-	-	-	-	-	-
Reactor	-	-	-	-	-	-	-	-	-	-	-	-	-	✓	-	-	✓	-	-	-
Additional refrigerant	-	-	-	-	-	-	-	-	-	-	-	-	-	-	✓	-	-	-	✓	-
Compressor	-	-	-	-	-	-	-	-	-	-	-	-	-	-	-	✓	-	-	-	✓
IPM module board	-	-	-	-	-	-	-	-	-	-	-	-	-	-	-	✓	✓	✓	-	✓
High pressure protector	-	-	-	-	-	-	-	-	-	-	-	-	-	-	-	-	-	✓	-	-
Low pressure protector	-	-	-	-	-	-	-	-	-	-	-	-	-	-	-	-	-	-	✓	-
Radar	-	-	-	-	-	-	-	-	-	-	-	-	ü	-	-	-	-	-	-	-

Table 16 Part replacement by error code



For certain models the outdoor PCB can not be removed separately. In this case, the outdoor electric control box should be replaced as a whole.

## 5.7 Troubleshooting by error code

### 5.7.1 EH 00/EH 0A: Indoor unit EEPROM parameter error

#### Digital output

- EH 00/EH 0A

#### Description

- Indoor PCB main chip does not receive feedback from EEPROM chip.

#### Recommended parts to prepare

- Indoor PCB

#### Procedure

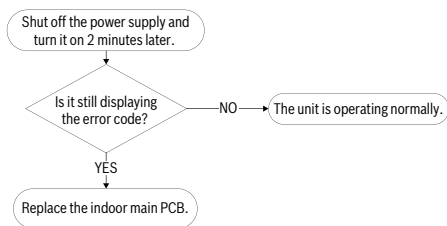

#### Additional information

A EEPROM is a read-only memory whose contents can be erased and reprogrammed using a pulsed voltage. The location of the EEPROM chip on the indoor PCB is shown in the following image:

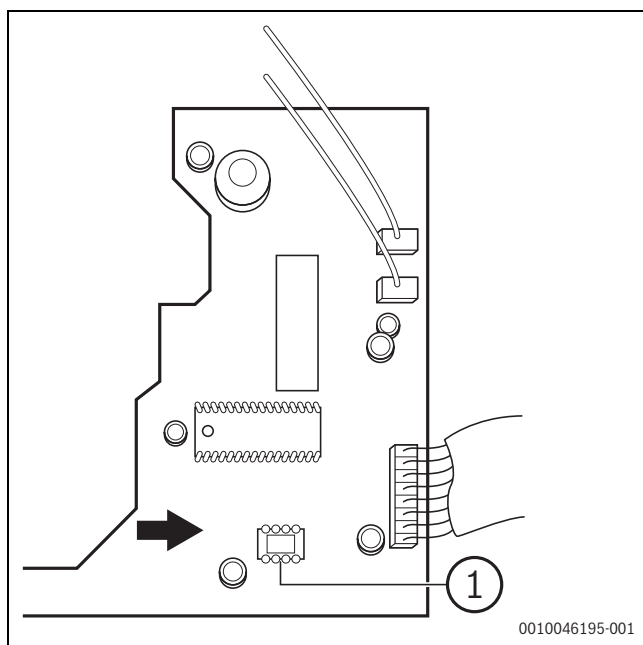

Fig. 20 EEPROM

[1] EEPROM chip



The picture is for reference only. The actual appearance may vary.

**5.7.2 EC 51: Outdoor EEPROM parameter error or communication error between the outdoor main chip and compressor driven chip  
EEPROM parameter error**

**Digital output**

- EC 51

**Description**

- The main chip of the outdoor PCB does not receive feedback from EEPROM chip or from the compressor driven chip.

**Recommended parts to prepare**

- Outdoor PCB

**Procedure**

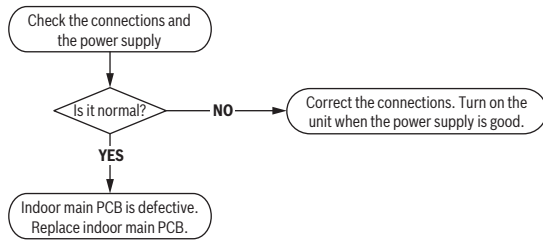

0010056433-001

**Additional information**

A EEPROM is a read-only memory whose contents can be erased and reprogrammed using a pulsed voltage. The location of the EEPROM chip on the outdoor PCB is shown in the following image:

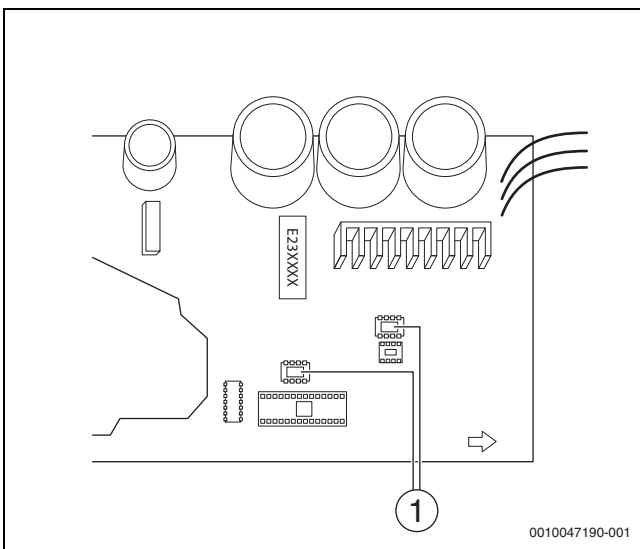

0010047190-001

Fig. 21 EEPROM

[1] EEPROM chip



For certain models, the outdoor PCB cannot be removed separately. In these cases, the outdoor electric control box should be replaced as a whole.

This picture is for reference only. The actual appearance may vary.

**5.7.3 EL 01: Communication error between the indoor and outdoor units**

**Digital output**

- EL 01

**Description**

- The indoor unit cannot communicate with the outdoor unit.

**Recommended parts to prepare**

- Indoor PCB
- Outdoor PCB
- Short-circuited component

**Procedure**



0010056621-001

**i** For certain models, the outdoor PCB cannot be removed separately. In these cases, the outdoor electric control box should be replaced as a whole.

**Additional information**

- Use a multimeter to test the DC voltage between 2 port (or S or L2 port) and 3 port (or N or S port) of the outdoor unit. The red pin of the multimeter connects with 2 port (or S or L2 port) while the black pin is for 3 port (or N or S port).
- When the unit is running normally, the voltage will move alternately between  $-25\text{V}$  and  $25\text{V}$ .
- If the outdoor unit has a malfunction, the value of the voltage will move alternately between a positive value.
- If the indoor unit has a malfunction, the value of the voltage is fixed.

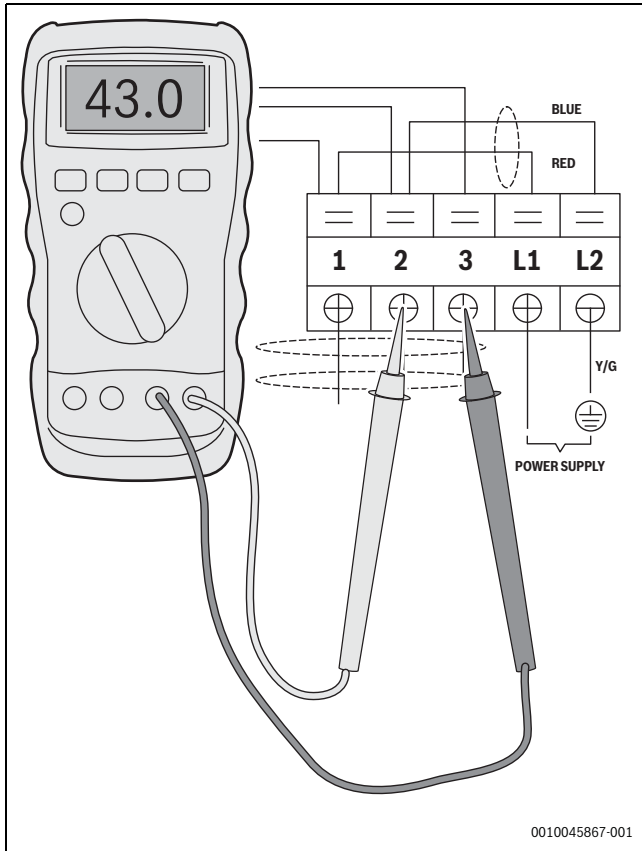

Fig. 22 Test the DC voltage

- Use a multimeter to test the resistance of the reactor which does not connect with the capacitor.
- The normal value should be around  $0\ \Omega$ . If the value is different, the check for a malfunction of the reactor.

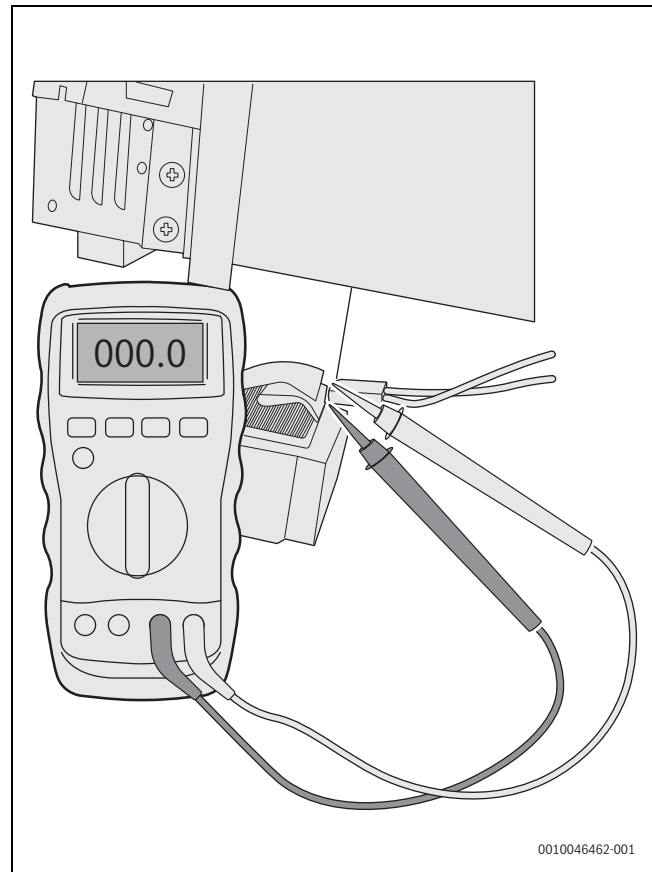

Fig. 23 Test the resistance



The pictures and the values are for reference only. The actual condition and specific value may vary.

### 5.7.4 EH 02: Zero crossing detection error

#### Digital output

- EH 02

#### Description

- The PCB main chip does not receive feedback for 4 minutes or the zero crossing signal time interval is abnormal.

#### Recommended parts to prepare

- Connection wires
- Indoor main PCB

#### Procedure

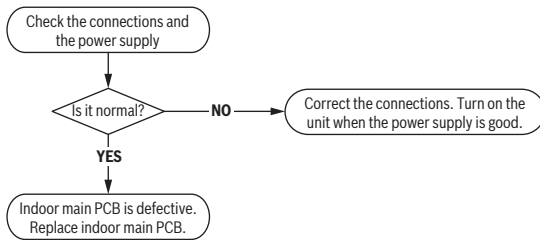

0010056433-001

#### Additional information



The zero crossing detection error is only valid for the unit with AC fan motor. For other models, this error is invalid.

### 5.7.5 EH 03: Indoor fan speed is operating outside of the normal range

#### Digital output

- EH 03

#### Description

- When the indoor fan speed is too low or too high for a certain time, the LED displays the error code and the unit turns off.

#### Recommended parts to prepare

- Connection wires
- Fan assembly
- Fan motor
- Indoor main PCB

#### Additional information

##### Indoor DC fan motor (the control chip is in fan motor):

- ▶ Power on the unit.
- ▶ When the unit is in standby, measure the voltage of pin1-pin3, pin4-pin3 in the fan motor connector.
  - If he value of the voltage is not in the range shown in the table below, the PCB has a problem and needs to be replaced.

No.	Color	Signal	Voltage
1	Red	Vs/Vm	192 ~380 V
2	–	–	–
3	Black	GND	0V
4	White	Vcc	14 ~17.5 V
5	Yellow	Vsp	0~5.6 V
6	Blue	FG	14 ~17.5 V

Table 17 Input and output voltage of the DC motor (voltage: 220 V-240 V~)

#### Procedure

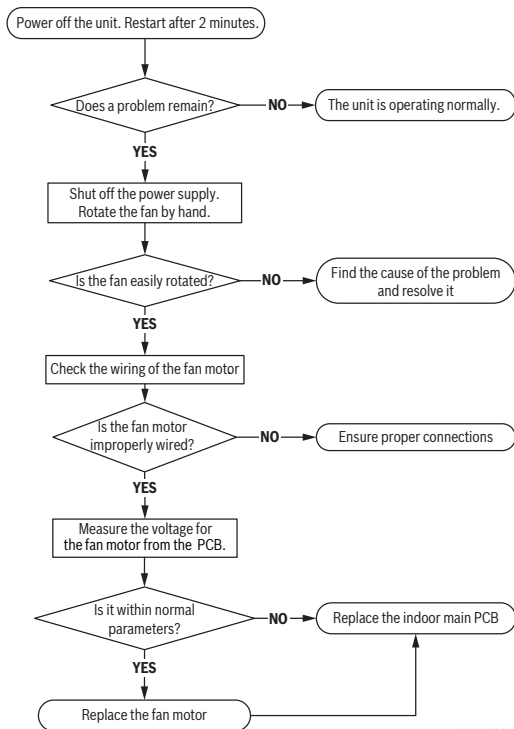

**5.7.6 EC 07: The outdoor fan speed is operating outside of the normal range**

**Digital output**

- EC 07

**Description**

- When the outdoor fan is too low for a certain time, the LED displays the error code and the unit turns off.

**Recommended parts to prepare**

- Connection wires
- Fan assembly
- Fan motor
- Outdoor main PCB

**Procedure**

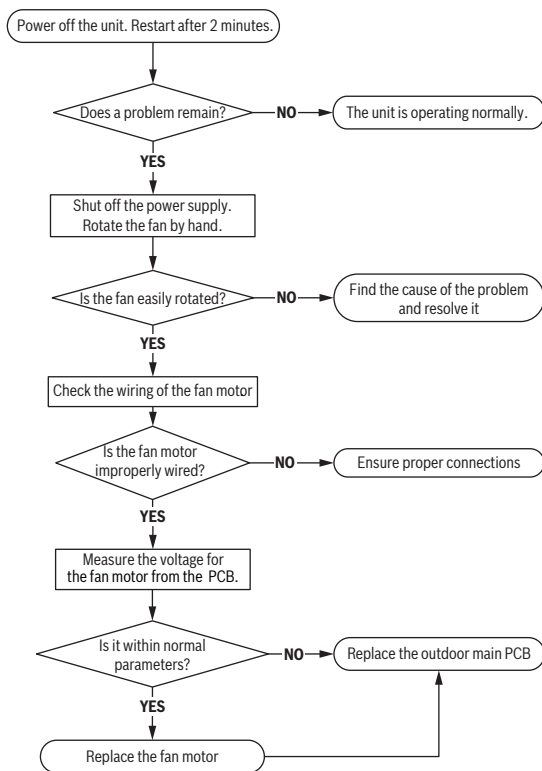

0010056619-001



For some models, the outdoor PCB cannot be removed separately. In these cases, the outdoor electric control box should be replaced as a whole.

**Additional information**

**Outdoor DC Fan Motor (the control chip is in the outdoor PCB):**

1. Release the UVW connector.
2. Measure the resistance of U-V, U-W, V-W.
3. If the resistance is not equal to each other, the fan motor or the PCB has a problem and needs to be replaced.

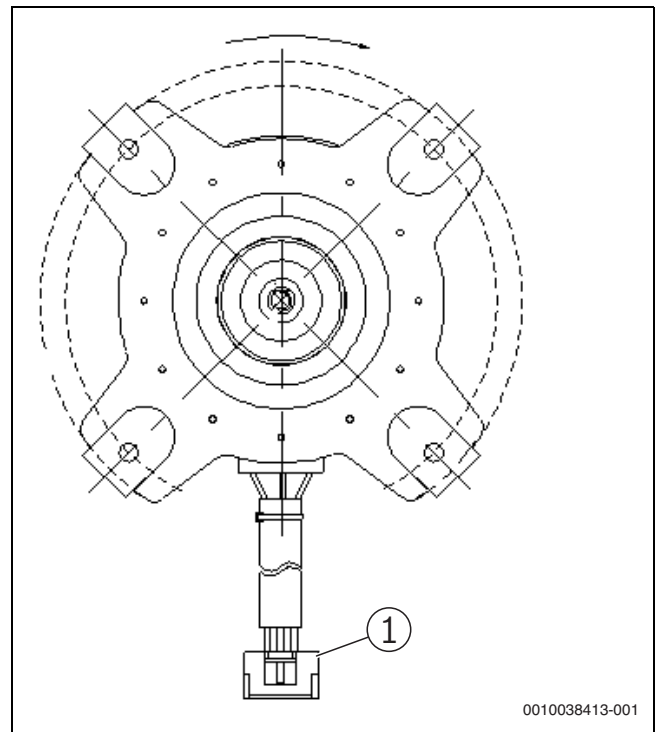

0010038413-001

Fig. 24 Fan motor connector (the control chip is in the outdoor PCB)

[1] UVW connector

### 5.7.7 EH 60, EH 61: Open or short circuit of indoor temperature sensors

#### Digital output

- EH 60 (T1 sensor)
- EH 61 (T2 sensor)

#### Description

- If the sampling voltage is lower than 0.06V or higher than 4.94V, the LED displays the error code.

#### Recommended parts to prepare

- Connection wires
- Sensors
- Indoor main PCB

#### Procedure

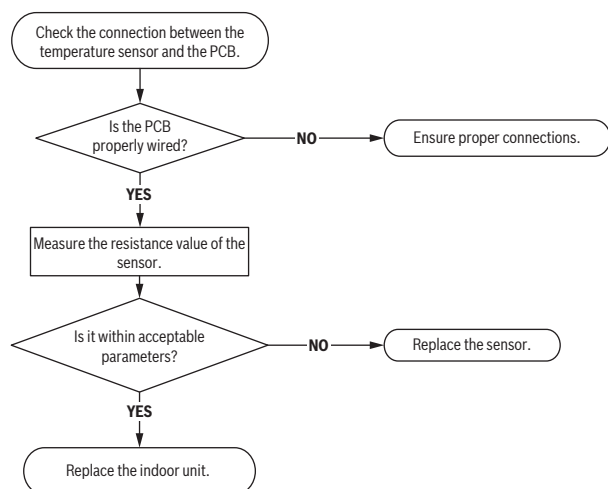

0010056435-001

#### Additional information

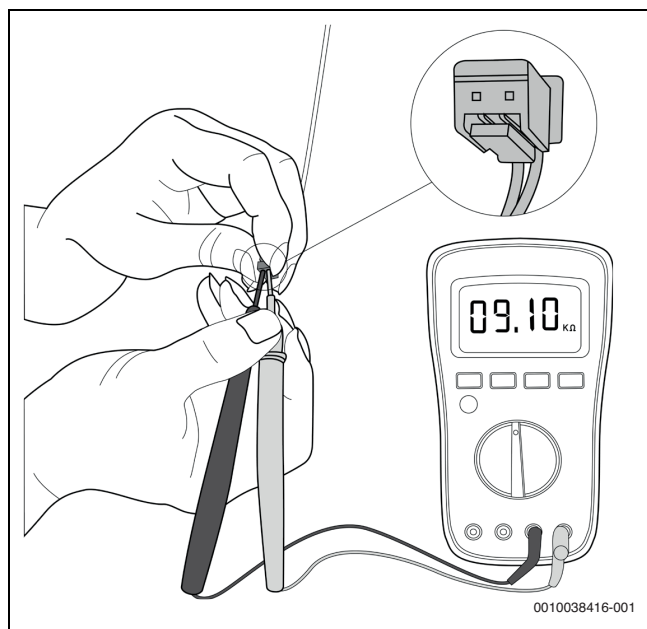

Fig. 25



This picture and value are for reference only. The actual appearance and value may vary.

**5.7.8 EC 52, EC 53, EC 54, EC 56: Open or short circuit of outdoor temperature sensors**

**Digital output**

- EC 52 (T3 sensor)
- EC 53 (T4 sensor)
- EC 54 (TP sensor)
- EC 56 (T2B sensor)

**Description**

- If the sampling voltage is lower than 0.06V or higher than 4.94V, the LED displays the error code.

**Recommended parts to prepare**

- Connection wires
- Sensors
- Outdoor main PCB

**Procedure**

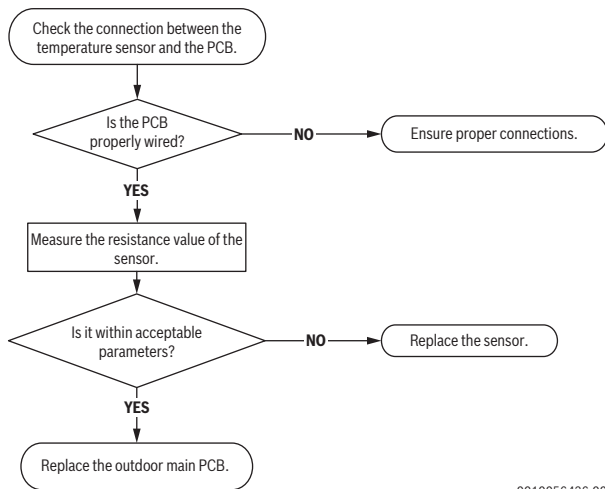

0010056436-001

**Additional information**

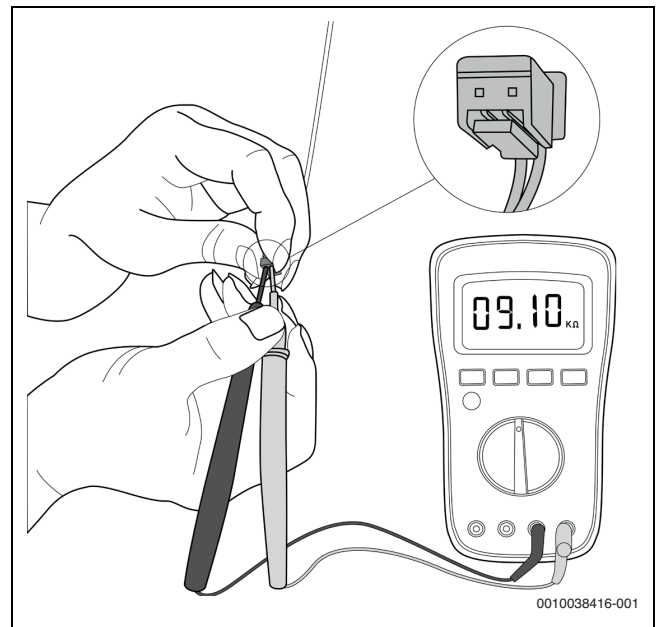

Fig. 26

**i** For certain models, the outdoor PCB cannot be removed separately. In these cases, the outdoor electric control box should be replaced as a whole.  
 For certain models, the outdoor unit uses combination sensor, T3,T4 and TP are the same of sensor.  
 This picture and the value are for reference only. The actual appearance and value may vary.

### 5.7.9 EL OC: Refrigerant leakage detection

#### Digital output

- EL OC

#### Description

The refrigeration system malfunction should be evaluated according to the number of the compressor stops and the changes in the operating parameters caused by the exhaust temperature.

#### Recommended parts to prepare

- Indoor PCB
- Additional refrigerant

#### Procedure

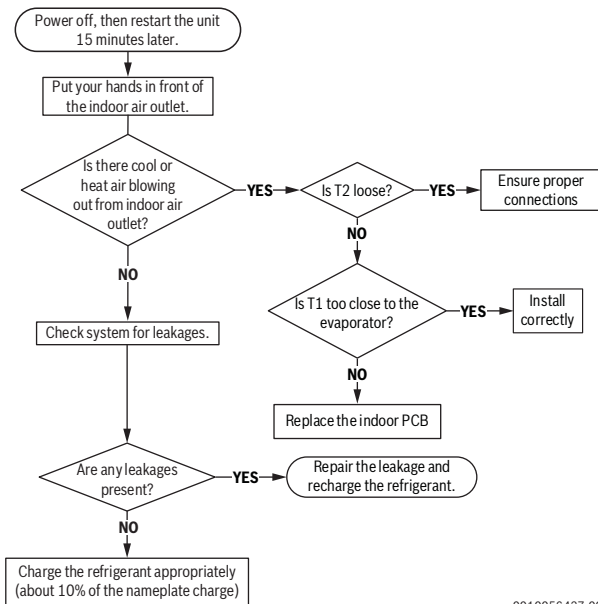

0010056437-001

Fig. 27

**5.7.10 EH 0b: Indoor PCB/display board communication error**

**Digital output**

- EH 0b

**Description**

- The indoor PCB does not receive feedback from the display board.

**Recommended parts to prepare**

- Connection wire
- Indoor PCB
- Display board

**Procedure**

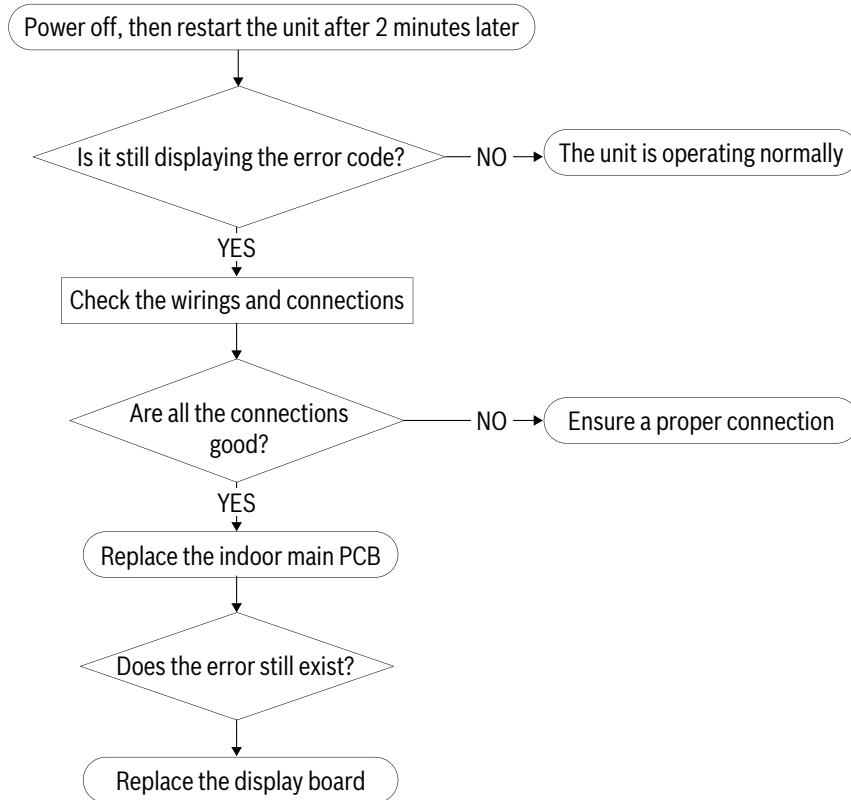

**5.7.11 PC 00: IPM malfunction or IGBT over-strong current protection**

**Digital output**

- PC 00

**Description**

When the voltage signal sent by the IPM to the compressor drive chip is abnormal, the LED displays the error code and the unit turns off.

**Recommended parts to prepare**

- Connection wires
- IPM module board
- Outdoor fan assembly
- Compressor
- Outdoor PCB

**Procedure**

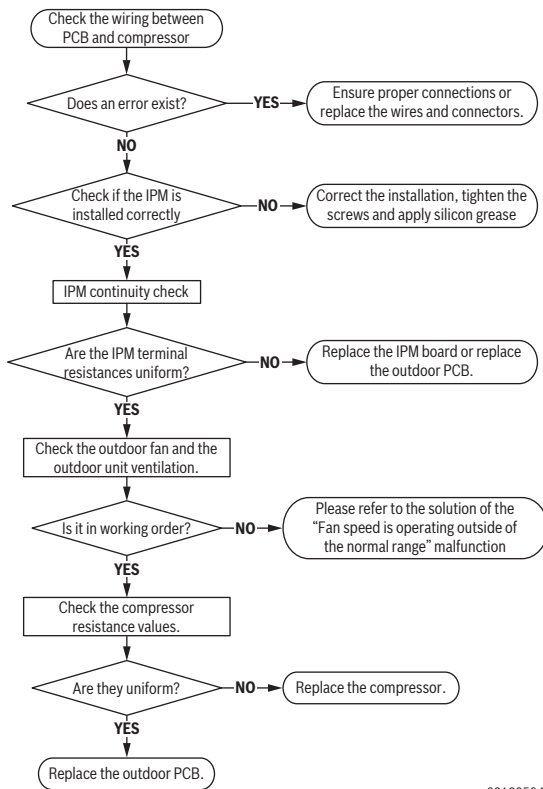

0010056438-001



For certain models, the outdoor PCB cannot be removed separately. In these cases, the outdoor electric control box should be replaced as a whole.

**5.7.12 PC 01: Over-voltage or undervoltage protection**

**Digital output**

- PC 01

**Description**

Abnormal increases or decreases in voltage are detected by checking the specified voltage detection circuit.

**Recommended parts to prepare**

- Power supply wires
- IPM module board
- PCB
- Reactor

**Procedure**

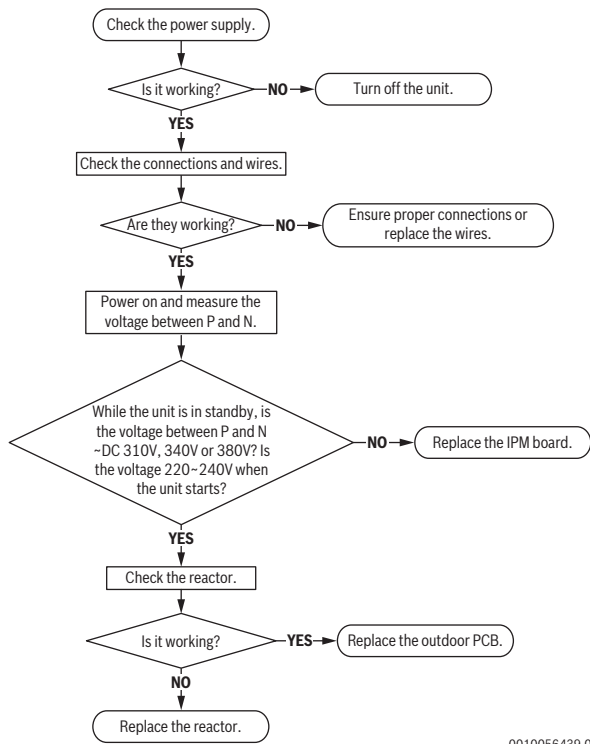

0010056439-001



For certain models, the outdoor PCB cannot be removed separately. In these cases, the outdoor electric control box should be replaced as a whole.

### 5.7.13 PC 02: High temperature protection of compressor/high temperature protection of the IPM module

#### Digital output

- PC 02

#### Description

- In models with overload protection, if the sampling voltage is not 5V, the LED will display the error code
- If the temperature of IPM module is higher than a given value, the LED displays the error code.
- In models with a high pressure switch, the outdoor pressure turns the system off when the high pressure is higher than 4.4 MPa. The LED will display the error code

#### Recommended parts to prepare

- Connection wires
- Outdoor PCB
- IPM module board
- High pressure protector
- System blockages

#### Procedure

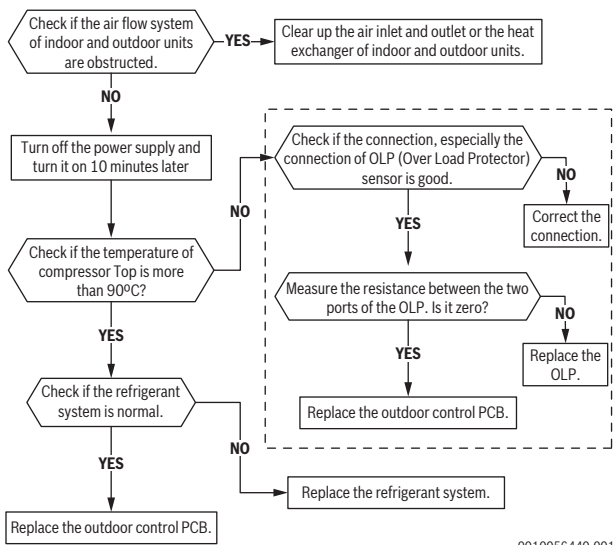

-- These steps are not applicable to models which the electronic control box cover cannot be removed.

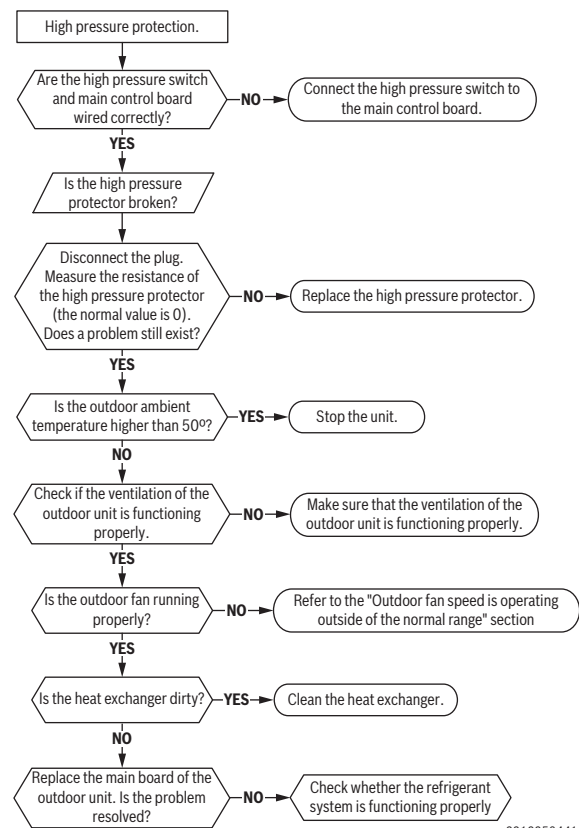
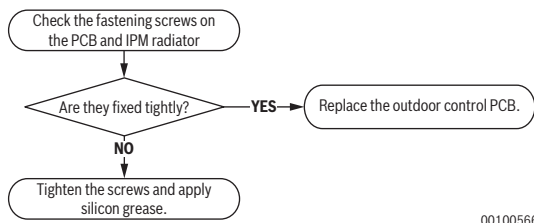

For certain models, the outdoor PCB cannot be removed separately. In these cases, the outdoor electric control box should be replaced as a whole.

### 5.7.14 PC 03: Low pressure protection

#### Digital output

- PC 03

#### Description

The outdoor pressure switch shuts the system down when the low pressure value is lower than 0.13 MPa. The LED will display the error code.

#### Recommended parts to prepare

- Connection wires
- Outdoor PCB
- Refrigerant
- Pressure switch
- Outdoor fan

#### Procedure

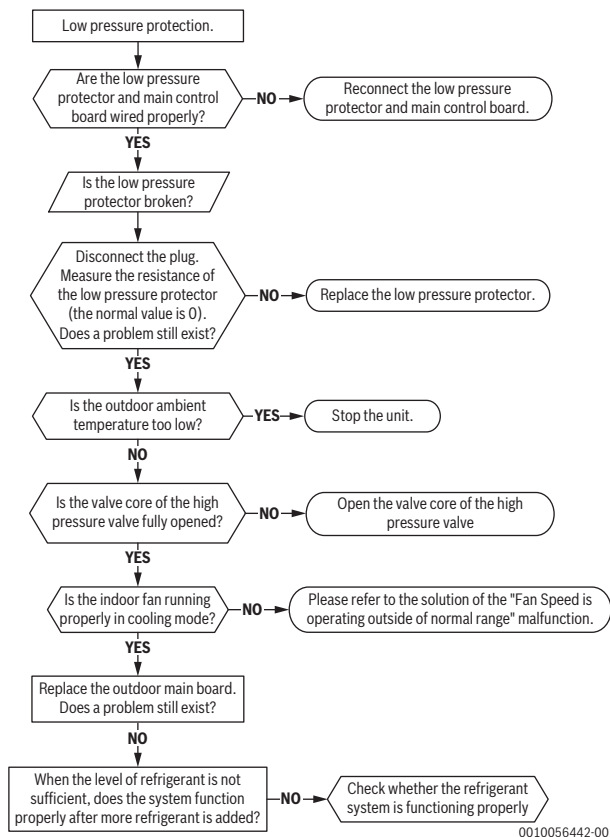

For certain models, outdoor PCB could not be removed separately. In this case, the outdoor electric control box should be replaced as a whole.

### 5.7.15 PC 04: Inverter compressor drive error

#### Digital output

- PC 04

#### Description

An abnormal inverter compressor drive is detected by a special detection circuit which includes a communication signal detection, voltage detection and a compressor rotation speed signal detection.

#### Recommended parts to prepare

- Connection wires
- IPM module board
- Outdoor fan assembly
- Compressor
- Outdoor PCB

#### Procedure

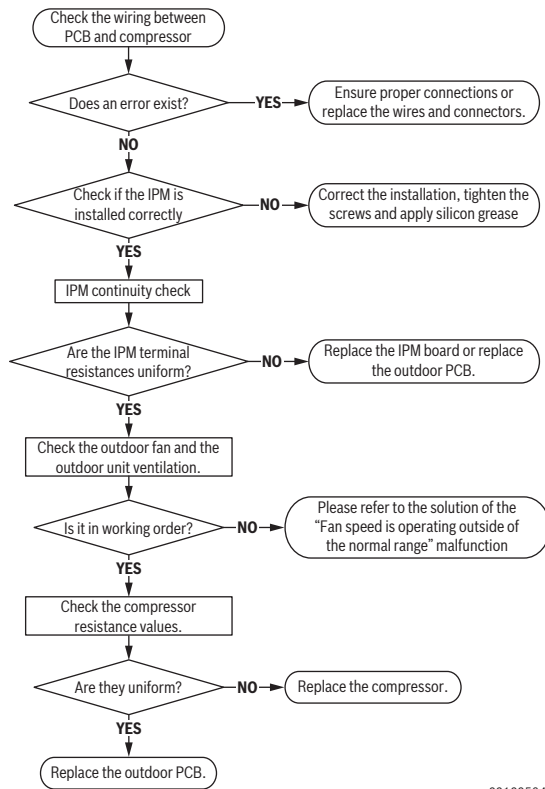

0010056438-001



For certain models, outdoor PCB cannot be removed separately. In these cases, the outdoor electric control box should be replaced as a whole.

**5.7.16 -- : Indoor units mode conflict**

**Digital output**

- --

**Description**

The indoor units cannot work in cooling and heating mode at the same time. Heating mode has the priority.

- Case A: indoor unit A is working in cooling or fan mode and the indoor unit B is set to heating mode. The indoor unit A will switch to off and the indoor unit B will continue to work in heating mode.
- Case B: indoor unit A is working in heating mode and the indoor unit B is set to cooling or fan mode. The indoor unit B will change to stand by and the indoor unit A will continue working in heating mode.

	Cooling mode	Heating mode	Fan	Off
Cooling mode	No	Yes	No	No
Heating mode	Yes	No	Yes	No
Fan	No	Yes	No	No
Off	No	No	No	No

Table 18 Mode conflicts

Yes Mode conflict  
 No No mode conflict

**5.7.17 FH OP: AP mode is active but there is no Wi-Fi kit installed**

**Digital output**

- FH OP

**Description**

The AP mode is active but it cannot detect the Wi-Fi kit.

**Recommended parts to prepare**

- Wi-Fi kit

**Procedure**

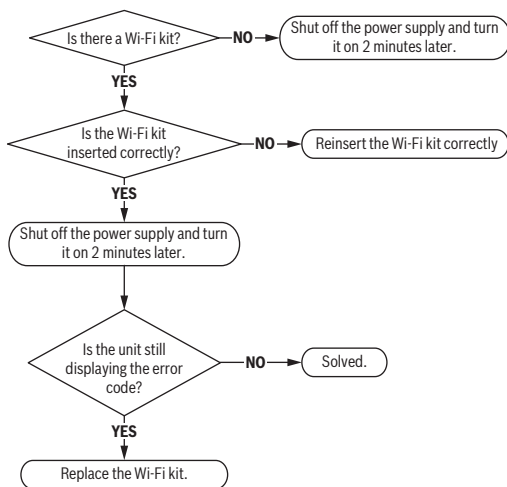

0010056443-001

Fig. 28

### 5.7.18 EH bE: Communication error between the radar and the display board/radar error

#### Digital output

- EH bE

#### Description

- The display PCB does not receive feedback from the radar.
- The radar is faulty.

#### Recommended parts to prepare

- Communication wire
- Radar
- Display board

#### Procedure

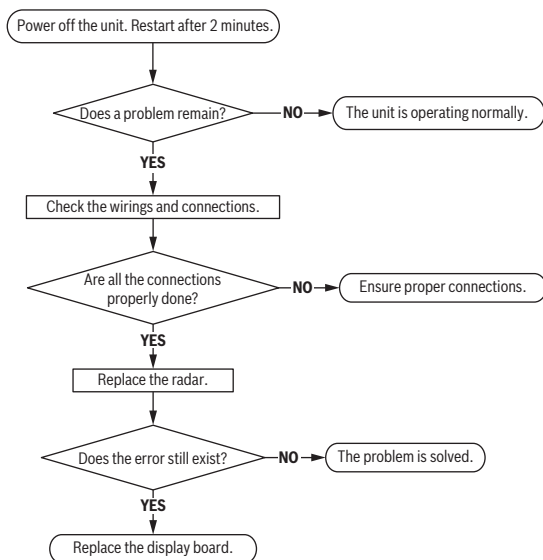

0010056444-001

Fig. 29



Any faults in the radar will only be displayed when this function is activated.

## 6 Check procedures

### 6.1 Before checking

**CAUTION**

**Risk of injury from electric shock!**

Electricity remains in capacitors even when the power supply is off.

- ▶ Ensure the capacitors are fully discharged before troubleshooting
- ▶ Be sure to turn off all power supplies or disconnect all wires to avoid electric shock.

**CAUTION**

**Danger of burns!**

During operation the compressor becomes hot.

- ▶ Operate after compressor and coil have returned to normal temperature in order to avoid injury.

### 6.2 Temperature sensor check

- ▶ Disconnect the temperature sensor from the PCB.
- ▶ Measure the resistance value of the sensor using a multi-meter.

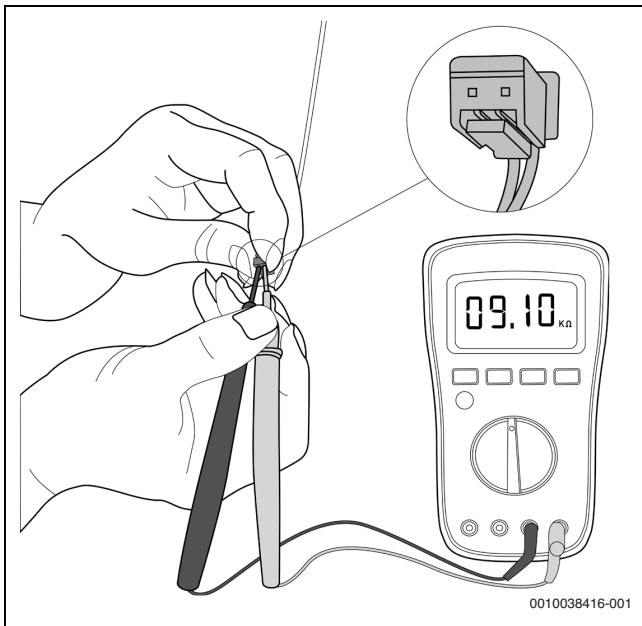

Fig. 30 Temperature sensor check

- ▶ Check corresponding temperature sensor resistance value table (→ chapters 7.1 and 7.2).



The picture and the value are only for reference, actual condition and specific value may vary.

### 6.3 Compressor check

- ▶ Disconnect the power cord of the compressor from the outdoor PCB.
- ▶ Measure the resistance value of each winding with a multi-meter.
- ▶ Check the resistance value of each winding in the following table.

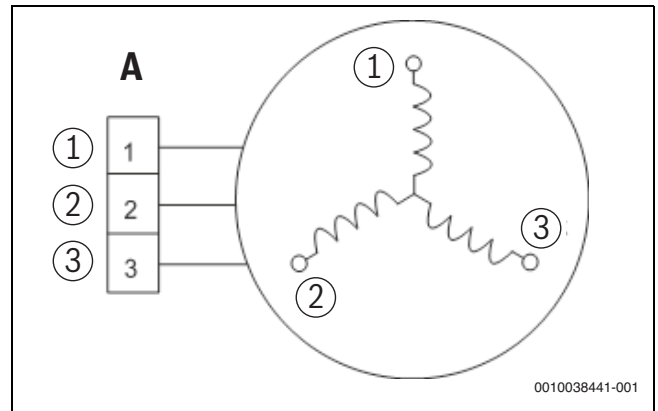

Fig. 31 Compressor check – input terminal

[A] Input terminal

[1] Blue

[2] Red

[3] Black

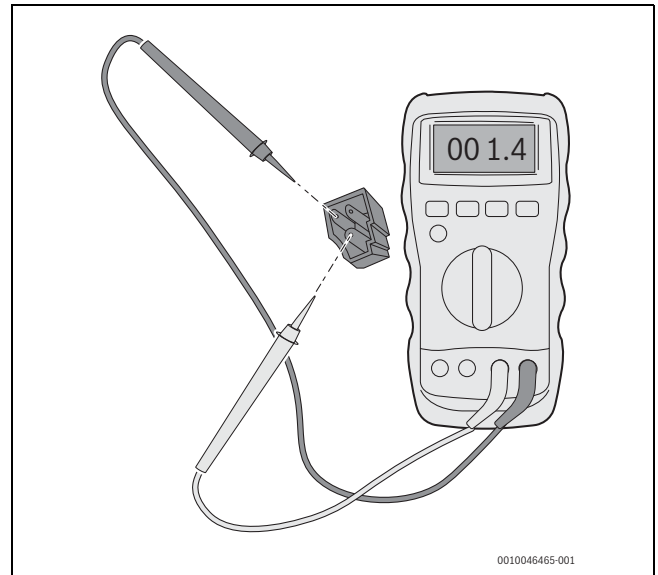

Fig. 32 Compressor check



The picture and the value are only for reference. The actual condition and specific value may vary.

### 6.4 IPM continuity check



**WARNING**

**Risk of electric shock.**

Electricity remains in capacitors even when the power supply is off.

- ▶ Make sure that the capacitors are fully discharged before troubleshooting.



Only a certified electrician is allowed to perform the IPM continuity check.

1. Turn off the outdoor unit.
2. Disconnect the power supply.
3. Discharge the electrolytic capacitors and make sure that all energy-storage unit has been discharged.
4. Disassemble the outdoor PCB or the IPM board.
5. Measure the resistance value between P and U(V, W, N); U(V, W) and N.

Digital tester		Resistance value
(+) Red	(-) Black	
P	N	$\infty$ (Several M $\Omega$ )
	U	
	V	
	W	
U	N	
V		
W		
-		

Table 19 Resistance value

**Test the conductivity of the IPM with diode mode**

Digital tester		Resistance value
(+) Red	(-) Black	
P	U	Open-circuit
	V	
	W	
N	U	0.3 – 0.5V
	V	
	W	

Table 20

Digital tester		Resistance value
(-) Black	(+) Red	
P	U	0.3 – 0.5V
	V	
	W	
N	U	Open-circuit
	V	
	W	

Table 21

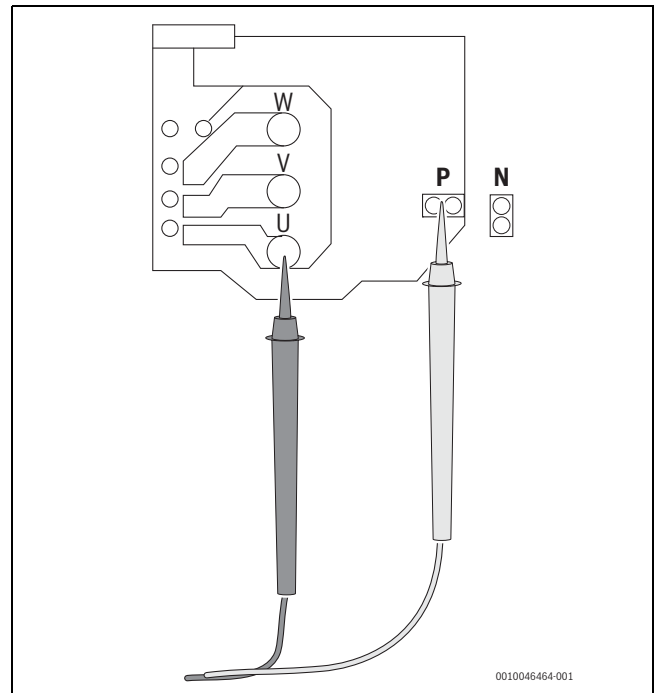

Fig. 33 Measure the resistance value



The picture and the value are only for reference, actual condition and specific value may vary.

### 6.5 4-way valve check

1. Power on the unit.
2. Use a digital tester to measure the voltage.
  - When the unit operates in cooling mode, the voltage is 0V.
  - When the unit operates in heating mode, the voltage is 230V AC.



If the voltage is not in the range, the PCB must be replaced.

3. Turn the power off.
4. Use a digital tester to measure the resistance value that should be 1.8 - 2.5K  $\Omega$ .



The values are for reference only. The actual conditions and specific values may vary.

**6.6 EXV check**



**WARNING**

**Risk of electric shock.**

Electricity remains in capacitors even when the power supply is off.

- ▶ Make sure that the capacitors are fully discharged before troubleshooting.

1. Disconnect the connector from the outdoor PCB.
2. Measure the resistance value of each winding using a multi-meter.
3. Check the resistance values of each winding using Table .
4. Use a digital tester to measure the voltage.

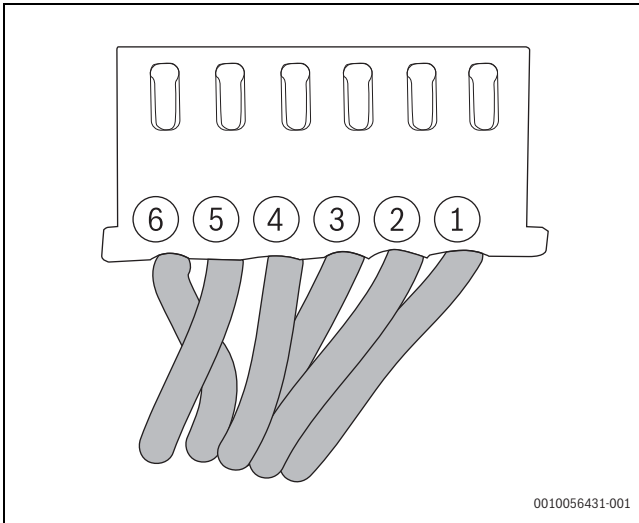

Fig. 34 EXV

- [1] White
- [2] Yellow
- [3] Orange
- [4] Blue
- [5] Brown
- [6] Red

Color of the lead winding	Normal value
Red – blue	~500 Ω
Red – yellow	
Brown – orange	
Brown – white	

Table 22

## 7 Appendix

### 7.1 Temperature sensor resistance values for T1, T2, T3 and T4

°C	K Ω	°C	K Ω	°C	K Ω	°C	K Ω
-20	115.26	20	12.6431	60	2.35774	100	0.62973
-19	108.146	21	12.0561	61	2.27249	101	0.61148
-18	101.517	22	11.5	62	2.19073	102	0.59386
-17	96.3423	23	10.9731	63	2.11241	103	0.57683
-16	89.5865	24	10.4736	64	2.03732	104	0.56038
-15	84.219	25	10	65	1.96532	105	0.54448
-14	79.311	26	9.55074	66	1.89627	106	0.52912
-13	74.536	27	9.12445	67	1.83003	107	0.51426
-12	70.1698	28	8.71983	68	1.76647	108	0.49989
-11	66.0898	29	8.33566	69	1.70547	109	0.486
-10	62.2756	30	7.97078	70	1.64691	110	0.47256
-9	58.7079	31	7.62411	71	1.59068	111	0.45957
-8	56.3694	32	7.29464	72	1.53668	112	0.44699
-7	52.2438	33	6.98142	73	1.48481	113	0.43482
-6	49.3161	34	6.68355	74	1.43498	114	0.42304
-5	46.5725	35	6.40021	75	1.38703	115	0.41164
-4	44	36	6.13059	76	1.34105	116	0.4006
-3	41.5878	37	5.87359	77	1.29078	117	0.38991
-2	39.8239	38	5.62961	78	1.25423	118	0.37956
-1	37.1988	39	5.39689	79	1.2133	119	0.36954
0	35.2024	40	5.17519	80	1.17393	120	0.35982
1	33.3269	41	4.96392	81	1.13604	121	0.35042
2	31.5635	42	4.76253	82	1.09958	122	0.3413
3	29.9058	43	4.5705	83	1.06448	123	0.33246
4	28.3459	44	4.38736	84	1.03069	124	0.3239
5	26.8778	45	4.21263	85	0.99815	125	0.31559
6	25.4954	46	4.04589	86	0.96681	126	0.30754
7	24.1932	47	3.88673	87	0.93662	127	0.29974
8	22.5662	48	3.73476	88	0.90753	128	0.29216
9	21.8094	49	3.58962	89	0.8795	129	0.28482
10	20.7184	50	3.45097	90	0.85248	130	0.2777
11	19.6891	51	3.31847	91	0.82643	131	0.27078
12	18.7177	52	3.19183	92	0.80132	132	0.26408
13	17.8005	53	3.07075	93	0.77709	133	0.25757
14	16.9341	54	2.95896	94	0.75373	134	0.25125
15	16.1156	55	2.84421	95	0.73119	135	0.24512
16	15.3418	56	2.73823	96	0.70944	136	0.23916
17	14.6181	57	2.63682	97	0.68844	137	0.23338
18	13.918	58	2.53973	98	0.66818	138	0.22776
19	13.2631	59	2.44677	99	0.64862	139	0.22231

Table 23

**7.2 Temperature sensor resistance values for TP**

°C	K Ω	°C	K Ω	°C	K Ω	°C	K Ω
-20	542.7	20	68.66	60	13.59	100	3.702
-19	511.9	21	65.62	61	13.11	101	3.595
-18	483	22	62.73	62	12.65	102	3.492
-17	455.9	23	59.98	63	12.21	103	3.392
-16	430.5	24	57.37	64	11.79	104	3.296
-15	406.7	25	54.89	65	11.38	105	3.203
-14	384.3	26	52.53	66	10.99	106	3.113
-13	363.3	27	50.28	67	10.61	107	3.025
-12	343.6	28	48.14	68	10.25	108	2.941
-11	325.1	29	46.11	69	9.902	109	2.86
-10	307.7	30	44.17	70	9.569	110	2.781
-9	291.3	31	42.33	71	9.248	111	2.704
-8	275.9	32	40.57	72	8.94	112	2.63
-7	261.4	33	38.89	73	8.643	113	2.559
-6	247.8	34	37.3	74	8.358	114	2.489
-5	234.9	35	35.78	75	8.084	115	2.422
-4	222.8	36	34.32	76	7.82	116	2.357
-3	211.4	37	32.94	77	7.566	117	2.294
-2	200.7	38	31.62	78	7.321	118	2.233
-1	190.5	39	30.36	79	7.086	119	2.174
0	180.9	40	29.15	80	6.859	120	2.117
1	171.9	41	28	81	6.641	121	2.061
2	163.3	42	26.9	82	6.43	122	2.007
3	155.2	43	25.86	83	6.228	123	1.955
4	147.6	44	24.85	84	6.033	124	1.905
5	140.4	45	23.89	85	5.844	125	1.856
6	133.5	46	22.89	86	5.663	126	1.808
7	127.1	47	22.1	87	5.488	127	1.762
8	121	48	21.26	88	5.32	128	1.717
9	115.2	49	20.46	89	5.157	129	1.674
10	109.8	50	19.69	90	5	130	1.632
11	104.6	51	18.96	91	4.849	-	-
12	99.69	52	18.26	92	4.703	-	-
13	95.05	53	17.58	93	4.562	-	-
14	90.66	54	16.94	94	4.426	-	-
15	86.49	55	16.32	95	4.294	-	-
16	82.54	56	15.73	96	4.167	-	-
17	78.79	57	15.16	97	4.045	-	-
18	75.24	58	14.62	98	3.927	-	-
19	71.86	59	14.09	99	3.812	-	-

Table 24

### 7.3 Pressure on service port

#### 7.3.1 Cooling chart (R32)

IDU (DB/WB °C)	ODU (DB °C)									
	-17	-15	-9.44	7.22	23.89	29.44	35	40.56	46.11	48.89
<b>21.11 - 15</b>	6.5	6.6	7.4	8.2	8.4	8.0	8.3	8.8	10.3	10.8
<b>23.89 - 17.22</b>	6.8	6.9	8.1	8.8	8.8	8.5	8.9	9.3	10.9	11.4
<b>26.67 - 19.44</b>	7.2	7.3	8.7	9.7	9.5	9.1	9.3	9.8	11.4	12.1
<b>32.22 - 22.78</b>	7.9	8.0	9.8	10.7	10.5	9.7	10.2	10.8	12.6	13.3

Table 25 Values for BAR pressure unit

IDU (DB/WB °C)	ODU (DB °C)									
	-17	-15	-9.44	7.22	23.89	29.44	35	40.56	46.11	48.89
<b>21.11 - 15</b>	95	96	108	118	121	115	119	128	150	157
<b>23.89 - 17.22</b>	99	101	117	128	126	122	129	135	158	165
<b>26.67 - 19.44</b>	105	106	125	141	138	132	135	143	165	176
<b>32.22 - 22.78</b>	114	115	142	155	152	141	148	157	184	193

Table 26 Values for PSI pressure unit

IDU (DB/WB °C)	ODU (DB °C)									
	-17	-15	-9.44	7.22	23.89	29.44	35	40.56	46.11	48.89
<b>21.11 - 15</b>	0.65	0.66	0.74	0.82	0.84	0.80	0.83	0.88	1.03	1.08
<b>23.89 - 17.22</b>	0.68	0.69	0.81	0.88	0.88	0.85	0.89	0.93	1.09	1.14
<b>26.67 - 19.44</b>	0.72	0.73	0.87	0.97	0.95	0.91	0.93	0.98	1.14	1.21
<b>32.22 - 22.78</b>	0.79	0.80	0.98	1.07	1.05	0.97	1.02	1.08	1.26	1.31

Table 27 Values for MPa pressure unit

#### 7.3.2 Heating chart (R32)

ODU (DB/WB °C)	IDU (DB °C)		
	12.78	18.33	23.89
<b>13.89 - 11.67</b>	30.9	33.2	34.5
<b>8.33 - 6.11</b>	29.1	30.6	32.1
<b>2.78 - 0.56</b>	25.8	27.1	28.4
<b>-2.78 - -5</b>	23.3	25.9	26.8
<b>-8.33 - -10.56</b>	21.2	23.8	25.4
<b>-17 - -19</b>	18.9	20.9	21.9
<b>-27 - -28</b>	16.8	19.4	20.4

Table 28 Values for BAR pressure unit

ODU (DB/WB °C)	IDU (DB °C)		
	12.78	18.33	23.89
<b>13.89 - 11.67</b>	448	480	499
<b>8.33 - 6.11</b>	421	444	466
<b>2.78 - 0.56</b>	374	394	411
<b>-2.78 - -5</b>	337	375	389
<b>-8.33 - -10.56</b>	308	346	369
<b>-17 - -19</b>	273	303	318
<b>-27 - -28</b>	244	282	296

Table 29 Values for PSI pressure unit

ODU (DB/WB °C)	IDU (DB °C)		
	12.78	18.33	23.89
<b>13.89 - 11.67</b>	3.09	3.32	3.45
<b>8.33 - 6.11</b>	2.91	3.06	3.21
<b>2.78 - 0.56</b>	2.58	2.71	2.84
<b>-2.78 - -5</b>	2.33	2.59	2.68
<b>-8.33 - -10.56</b>	2.12	2.38	2.54
<b>-17 - -19</b>	1.89	2.09	2.19
<b>-27 - -28</b>	1.68	1.94	2.04

Table 30 Values for MPa pressure unit

**7.3.3 System pressure table (R32)**

Pressure			Temperature
[Kpa]	[bar]	[PSI]	[ °C]
100	1	14.5	-51.909
150	1.5	21.75	-43.635
200	2	29	-37.323
250	2.5	36.25	-32.15
300		43.5	-27.731
350	3.5	50.75	-23.85
400		58	-20.378
450	4.5	65.25	-17.225
500		72.5	-14.331
550	5.5	79.75	-11.65
600		87	-9.150
650	6.5	94.25	-6.805
700	7	101.5	-4.593
750	7.5	108.75	-2.498
800	8	116	-0.506
850	8.5	123.25	1.393
900	9	130.5	3.209
950	9.5	137.75	4.951
1000	10	145	6.624
1050	10.5	152.25	8.235
1100	11	159.5	9.790
1150	11.5	166.75	11.291
1200	12	174	12.745
1250	12.5	181.25	14.153
1300	13	188.5	15.52
1350	13.5	195.75	16.847
1400	14	203	18.138
1450	14.5	210.25	19.395
1500	15	217.5	20.619
1550	15.5	224.75	21.813
1600	16	232	22.978
1650	16.5	239.25	24.116
1700	17	246.5	25.229
1750	17.5	253.75	26.317
1800	18	261	27.382
1850	18.5	268.25	28.425
1900	19	275.5	29.447
1950	19.5	282.75	30.448
2000	20	290	31.431
2050	20.5	297.25	32.395
2100	21	304.5	33.341
2150	21.5	311.75	34.271
2200	22	319	35.184
2250	22.5	326.25	36.082
2300	23	333.5	36.965
2350	23.5	340.75	37.834
2400	24	348	38.688
2450	24.5	355.25	39.529
2500	25	362.5	40.358
2550	25.5	369.75	41.173
2600	26	377	41.977
2650	26.5	384.25	42.769
2700	27	391.5	43.55

Pressure			Temperature
[Kpa]	[bar]	[PSI]	[ °C]
2750	27.5	398.75	44.32
2800	28	406	45.079
2850	28.5	413.25	45.828
2900	29	420.5	46.567
2950	29.5	427.75	47.296
3000	30	435	48.015
3050	30.5	442.25	48.726
3100	31	449.5	49.428
3150	31.5	456.75	50.121
3200	32	464	50.806
3250	32.5	471.25	51.482
3300	33	478.5	52.15
3350	33.5	485.75	52.811
3400	40	493	53.464
3450	34.5	500.25	54.11
3500	35	507.5	54.748

Table 31





Bosch Thermotechnik GmbH  
Sophienstrasse 30-32  
35576 Wetzlar, Germany

[www.bosch-industrial.com](http://www.bosch-industrial.com)

